

HI·MACS

The shape of your ideas

General Brochure 2024/2025

Welcome to the world of HIMACS

Solid Surface Material

With many brand-new-projects
and new exciting products

Table of Contents

The Material

The Shape of your Ideas	03
What is HIMACS?	04-05
Sustainability	06-07
Outstanding Results	08-09

The Projects

Public Buildings and Museums	11-14
Education	15
Offices	16-18
Retail	19-20
Facades	21-24
Hospitality and Gastronomy	25-27
Furniture and Product Design	28-29
Healthcare	30-33
Living Spaces	34-35
Kitchen	36-39
Bathroom	40-41
Airport	42
Transport and Marine	43-45
All Time Favourites	46-47

The HIMACS Sheet

What makes the HIMACS Sheet so special	48-49
The Colours of HIMACS	50-51

The Collections

Gravilla	53
Aurora and Marmo	54-55
Solids	56-57
Terrazzo	58
Lucia	59
Concrete	60
Aster	61
Volcanics	62
Lucent	63
Granite, Quartz, Sand and Pearl	64-65
Advanced Series	66
Intense Ultra	67

The Shapes

Sinks and Basins	69-74
Baths & Shower Trays	75

Technical information

Processing and Quality	76-77
Technical data	78-79
Partners and Contact	80

HIMACS. The shape of your ideas

Every space, every object, every piece of architecture ever built was an inspired creation of an architect or designer. Some good, some great, some pure genius.

So, what will you create next?



Amazing that something so great is actually so simple



= **HI·MACS**

Just three ingredients are used to enable the endless possibilities of HIMACS:
Yes, it's as simple as that.

Photographed by Rafael Krötz

Sustainability is a way of thinking

It may sound like common sense today, but we need to remember nevertheless. **Because every step that's good for the environment and the climate is a crucial one.** Like encouraging our clients to utilise every piece of HIMACS they can.

Or adopting smart solutions to reduce energy consumption in the chain of logistics. Even using environmental-friendly packaging where possible. Our research and development teams are constantly looking for better ways to do things. And guess what? It's certified!

DGNB

German Sustainable Building Council (DGNB)
HIMACS has achieved quality level 4 out of 4 – the best rating – for the local environmental impact of the overall product (2018). The DGNB system is a holistic and unique certification system for sustainable construction.



Environmental Building Certificate – Grade “outstanding”

The Korean Air Cleaning Association certifies that HIMACS complies with the Korean regulations for environmental building materials



Environmental Product Declaration (EPD)

An environmental product declaration (EPD) reports the lifecycle assessment of a product in a single, comprehensive report, which is verified by UL Solutions against the international ISO 14025 standard. The HIMACS EPD provides information to buyers about a product's impact on the environment, such as global warming potential, smog creation, ozone depletion and water pollution.

BREEAM

delivered by bre

Building Research Establishment Environmental Assessment Method (BREEAM)

Among other ratings, the material complies with “Hea 02 Indoor Air Quality” for particularly good air quality. BREEAM is one of the world's most important global rating methods for sustainable architecture.



Leadership in Energy and Environmental Design (LEED)

A standard voluntary system to certify high performance of buildings, from the US Green Building Council (USGBC). LEED certifies buildings using a credit system. Architects and planners using HIMACS for their project can claim EQ Credit for Low-Emitting Materials with the category Indoor Environmental Quality (EQ).



SCS Global Services

SCS Global Services stands as a trusted leader in third-party environmental and sustainability certification, as well as in auditing, testing, and standards development. LX Hausys has been certified for its HIMACS Solid Surface products to contain SCS-certified pre-consumer recycled content for a selection of colours. For additional details, please refer to pages 62 and 65.

HIMACS...

- is used in installations that need to be visually attractive, and technically **extremely durable**.
- is very **easy to maintain** – mild detergent, some water, and a cloth or a sponge: that's it!
- is **easy to repair**.
- can **always be repurposed**. There is no waste.
- is **composed of high quality** materials and free of silica, formaldehyde, VOC emissions and nanoparticles.
- is produced in an **energy-efficient** and **resource-saving** manner in our plants in in Cheongju (Korea) and Atlanta (USA).
- comes with **certifications**, environmental **product declarations**, and **regular tests** like those listed in the previous page.

You can find more information on this topic in our “The Sustainable Quality of HIMACS” brochure and on www.lxhausys.com/eu.

What's so cool and extraordinary about HIMACS



Tight curves

HIMACS can be **thermoformed**. You are going to love this: heat the material up (e.g. in a laminate press) and mold it into any shape you like.

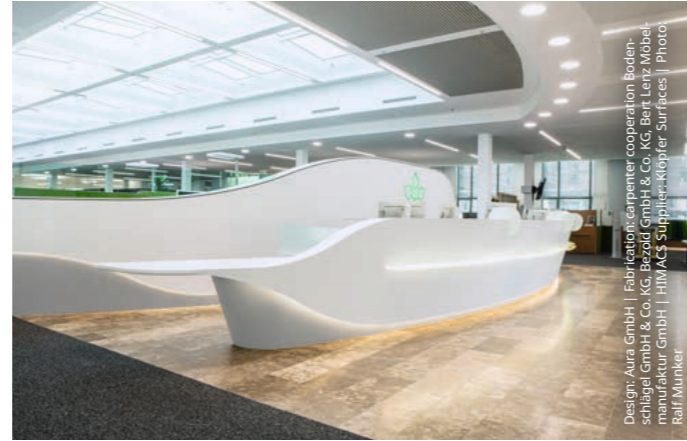

XXXL surfaces

You can bond one sheet of HIMACS to the next. You could easily build entire football fields from it! The icing on the cake – **no visible seams**.



Brilliant light effects

HIMACS is translucent. Just shine a light behind a piece and experience it for yourself. And now start dreaming what's possible!



United colours of fabulous

HIMACS is available in **about 100 colours**. Each one more beautiful than the next! Combine it with wood, glass, brass, copper ... you get the idea.



The details people fall in love with

A backlit starry sky, a small seamless shelf, a gentle basin. You make it up as you go along. And **build it in HIMACS**: Drill it, saw it, mill it, glue it, whatever you want. Like hardwood.



Highly functional shapes and bowls

Single basins, double basins, round basins. Kitchen sinks, wash-basins, bathtubs or shower trays. **Everything can be integrated without visible joins**. As undermount or topmount versions. Same material – same uni colours – always fits perfectly.



From high gloss to noble matt

HIMACS can be sanded into different finishes with an orbital sanding machine. **High gloss, satin**, whichever you prefer. Either way: HIMACS is a tactile champion, and always soft to the touch.



Stone look, fabricated by carpenters

All these advantages and effects can be achieved by carpenters with their **common hardwood tool**. Skilled craftsmen thus succeed in implementing extremely exciting projects within a manageable budget.

Public Buildings and Museums

High traffic, high requirements. Thankfully, HIMACS can handle a lot, and the relevant tests and certificates prove just that.

The Projects

Public Buildings and Museums | Education | Offices | Retail | Facades | Hospitality and Gastronomy | Furniture and Product Design | Healthcare | Living Spaces | Kitchen | Bathroom | Transport and Marine | All Time Favorites



Garda Síochána Headquarters

Location: Dublin, Ireland
Design: Office of Public Works
Fabrication: Solid Fabrications
HIMACS Supplier: James Latham
Material: HIMACS T010 Nebula
Photographer: Marie-Louise Halpenny

Stairway to heaven

Up to 900 Police employees work in the new Garda Síochána headquarters in Dublin. There's always lots of activity here. HIMACS was selected as the cladding for the staircase railings, bannisters and balustrades in the atrium because of its excellent durability and modern aesthetic. Good choice!



These walls tell stories



CNC milling machines routed various high-precision designs in the material

Deutsches Museum Munich Chemistry Exhibition

Location: Munich, Germany
 Design: Ambos & Weidenhammer Architekten
 Fabrication: Körling Interiors GmbH & Co. KG, Georg Ackermann GmbH
 HIMACS Supplier: Klöpfer Surfaces
 Material: HIMACS S028 Alpine White
 Photographer: Mueller-Naumann Photography

The layered high-tech HIMACS walls of the celebrated chemistry exhibition at the Deutsches Museum capture the subject matter, help visitors orientate themselves and offer transparency to spark curiosity.



Back to the future

The James Simon Gallery is the new reception building and visitors' centre on Berlin's Museum Island. The extremely high volume of visitors and heavy use of the facilities call for high-quality and extremely resistant materials. What can we say? HIMACS is the perfect choice here.



All of the counters in the new David Chipperfield building are constructed as solid, large-scale cubes. The design is made possible by the visually seamless craftsmanship of HIMACS.

Museumsinsel Berlin, James Simon Gallery

Location: Berlin, Germany
 Design: David Chipperfield Architects
 Fabrication: Tischlerei Drogoin GmbH
 HIMACS Supplier: Klöpfer Surfaces
 Material: HIMACS S028 Alpine White
 Photographer: Sandra Kühnapfel



Artist Lena Maria Emrich created a furore with her pieces in the "Soft Cruelties" exhibition: she milled, sawed, engraved and polished her work into HIMACS creations. It's an impressive fusion of technical precision and creative inspiration.

Conversational piece "Ménage-à-trois (Garden Eden)" showcases a filigree inlay.



The exhibition included, among other pieces, six reliefs that look like they were chiselled in stone.

Exhibition „Soft Cruelties“

Location: Kunstverein am Rosa-Luxemburg-Platz, Berlin, Germany

Design & Frabrication: Lena Marie Emrich

Material: HIMACS M603 Pavia, M615 Aurora Cotton, M705 Aurora Canyon, M706 Aurora Angora, G048 Beach Sand and M605 Sanremo

Photographer: Ludger Paffrath

Education

Schools and universities are full of young students who pay attention to many things around them, but handling furniture with care is not one of them. It is critical that the choice of material here must be extremely durable, easy to maintain and clean.

The building within a building

There are very few facade materials that can be perfectly moulded and connected to create surfaces as large-scale and homogeneous as this.

University of Sheffield

Location: Sheffield, United Kingdom

Design: HLM Architects

Fabrication: 3G Joinery & Shopfitting Ltd

HIMACS Supplier: James Latham

Material: HIMACS S028 Alpine White

Photographer: © Martine Hamilton Knight/Builtvision

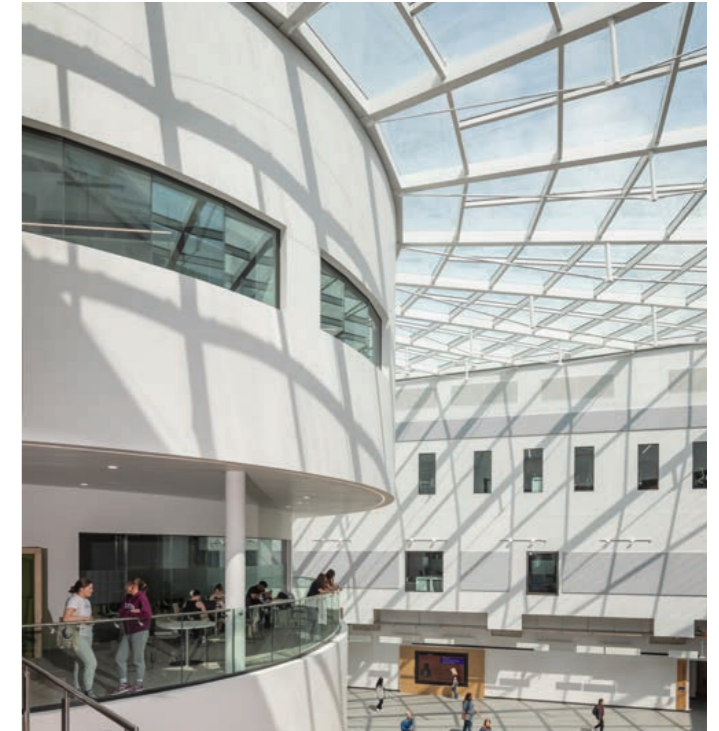

Offices

Brands and businesses need a way to express their identity, and they need a workplace that functions well and feels good. That's where HIMACS shines.

Mission: Inspiration!

The visually seamless connection creates a huge, homogeneous HIMACS surface.



“Work, live, learn” was the motto when this IT campus was designed. The XXXL kitchen is as multi-functional as this motto suggests: campus students meet here to chat, cook and eat together. The material used has to look good and, above all, handle a lot of use and be easy to maintain.



De Veense Tech Campus

Location: Netherlands
Design: Design & Meer and VRP architects
Fabrication: Design & Meer
HIMACS Supplier: Baars & Bloemhoff
Material: HIMACS G554 Urban Concrete
Photographer: Roos Jansen from Lichtgevoelig filmproducties



The future of mobility

ADAC is the largest automobile club in Germany – an institution with tradition. The new headquarters in Hamburg belie tradition with a completely futuristic look. The design plays with light, the decisive factor in the modern aesthetic. HIMACS in Alpine White acts like a large diffuser, softly reflecting and distributing the light.

Large, curved surfaces give a feeling of weightlessness. The visual paths and ramps created are reminiscent of a network of roads.



ADAC Central Office

Location: Hamburg, Germany
Design: Ninous Tatari Architects
Fabrication: Roskopf + Partner AG
HIMACS Supplier: Klöpfer Surfaces
Material: HIMACS S028 Alpine White
Photographer: John Schofeld

Retail

The standards and quality of a retailer are conveyed in part through the quality of the architecture. HIMACS helps put brands and products in the best light with the creative possibilities it offers.

Modern yet traditional, with a maritime – and tasty – design



This Belgian bakery has delivered excellent, delicious quality since 1913. The new shop space aimed to visually showcase the bakery's heritage while also creating a fresh and warm environment. A perfect job for HIMACS: warm to the touch, totally hygienic for preparing and serving food and elegantly pleasing to the eye, with blue maritime accents.



Contentful Offices

Location: Berlin, Germany
Design: toi toi toi creative studio
Fabrication: Markmann & Sabban
Objekteinrichtung
Carpentry Work: Discher Tischlerei GmbH
HIMACS Supplier: Klöpfer Surfaces
Material: HIMACS Q001 Terrazzo Classico
Photographer: koy & winkel fotografie



Agility can be built

This is what an innovative business wants to look like. On the ground floor, the reception counter, seating and even the integrated planters deliver the desired wow factor right from the start with their organic forms and chic terrazzo look.

Aerts Speculaas

Location: Lokeren, Belgium
Design: KLETZ
Fabrication: KLETZ
Material: HIMACS S203 Sky Blue and S028 Alpine White
Photographer: KLETZ



Bicycles and a cafe: the perfect mix



The interior of this luxury bicycle shop aimed to give off a cool, minimalist vibe. The white colour scheme with elegant gold accents presented the perfect contrast to the dark coloured premium bikes. The multi-functional HIMACS counter embodies minimalism and also offers the right kind of durable surface for a bike shop.

The work area in the cafe, also made of HIMACS, features flush-mounted sink.

Lumírova Bike Store

Location: Prague, Czech Republic
Design: P6PA+Architects, s.r.o., Martin Klejna, Julio Costa, Karel Koutský
Fabrication: DINAK spol. s r.o.
HIMACS Supplier: Polytrade CE
Material: S028 Alpine White
Photographer: Robert Žákovíč

Facades

Durability, high quality, design options. HIMACS can withstand all weather and UV conditions. Outdoor the material is a real all-rounder.

Expertise: Using HIMACS outdoors

HIMACS has been used for years in spectacular facades all over the world. Offering not only functional benefits, the material also delivers awesome aspects of design: artistically milled lettering and logos, backlit designs and curved contours – with HIMACS creativity knows no limits.



School Bairro do Mouço | Design: Falanstério Atelier de Arquitectura | Fabrication: Horta & Verissimo | HIMACS Supplier: Banema S.A. | Photographer: Tiago Casanova



LX Hausys is expanding possibilities for the outdoors with HIMACS Exteria®:

- S728 HIMACS-FR (Alpine White) is the FR version that for years has features increased fire resistance – certified by the ETA.
- S828 HIMACS-UV+ (Alpine White) is the new formulation, specifically optimised for outdoor use with even greater UV resistance. This is especially important for facades exposed to very intense sunlight.
- All HIMACS colours with the sun symbol can be safely used outdoors. The colours can be found on pages 52 to 67.

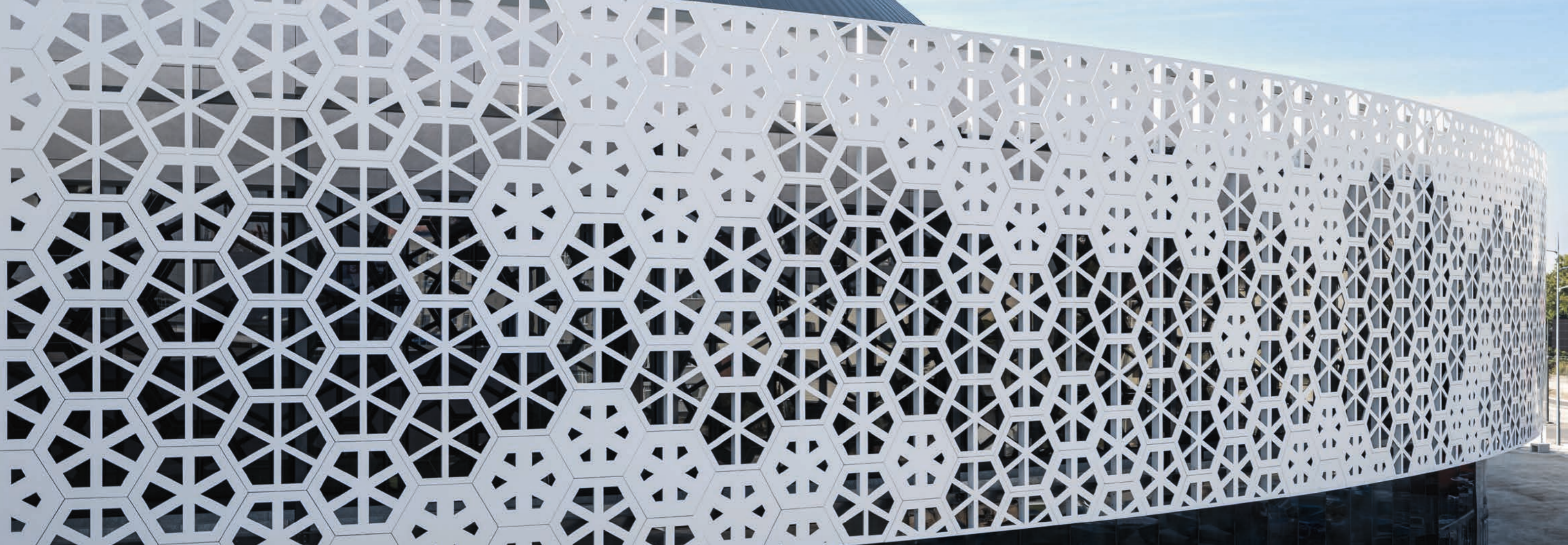

The stars shine bright outside

This wonderful facade of a sport hall complex is an impressive 2,100 m². HIMACS was chosen because of its aesthetic – and its certified fire resistance. HIMACS successfully underwent numerous fire resistance tests, and has received the NRO (Non Spreading Fire) certificate from the Polish Fire Test Facility (ITB), making it one of only a very few solid surface materials to be approved in Poland for use in outdoor facades.

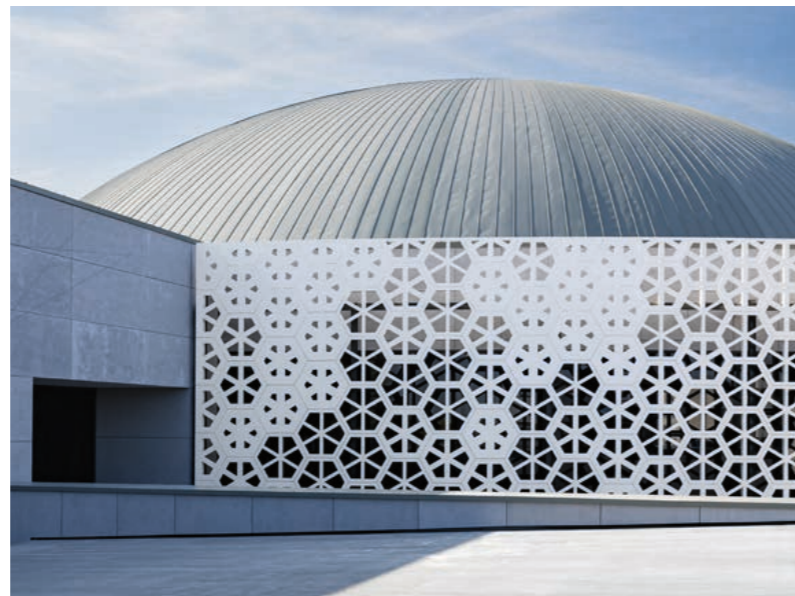

Modern CNC milling technology allowed all facade elements to be individually designed; the expansion joint – a required part of the facade – is transformed into a cool design element.

The geometric honeycomb pattern gives the building a sense of transparency and stability all at once.

Urania Olsztyn

Location: Olsztyn, Poland
Design: Dorota Szymaniak - Urban
Fabrication: Studio Reklamy Euromet
HIMACS Supplier: Patron-Bis Sp. Z o.o.
Material: HIMACS S028 Alpine White
Photographer: Cath Graz, Hubert de Jakusz-Gostomski





Hospitality and Gastronomy

Hotels, bars, restaurants, clubs. In these places, it's all about creating the right atmosphere. Not to mention delivering a solid performance. HIMACS is right at home here.

Classy. Both in the glass and in the room



Choosing wine and champagne from Louis Roederer shows a certain discerning taste. It only makes sense to underscore such an exquisite feeling by using exquisite materials. HIMACS delivers the highest precision, elegance and sophistication in curved form.

The striking HIMACS facade elements are a stark highlight of the complete renovation of this mall in Lille, France. They give the building structure and are integrated in the lighting concept as vertical reflection surfaces.

Facade Englos

Location: Englos (Lille), France
 Design: Victor Mota – No Problemo
 Fabrication: HUS Agencement
 HIMACS Supplier: Aska Interior
 Material: HIMACS S028 Alpine White
 Photographer: CYRBOX – Cyril Cornet

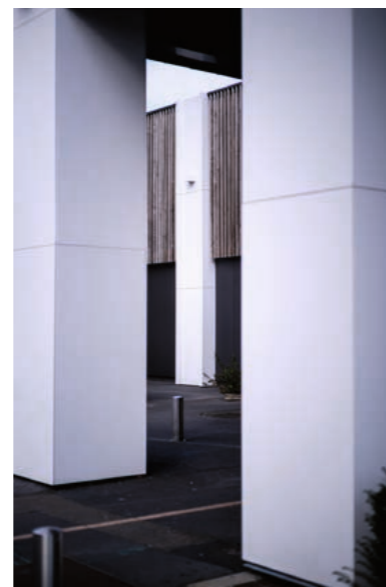

Louis Roederer Tasting Room

Location: Reims, France
 Architecture & Design: Alexandra Kalinine and Thomas Beauclair
 General Contractor: Frédéric Guyon - APB-INGENIERIE
 Fabrication: Kieffer Menuiserie
 HIMACS Supplier: Aska Interior
 Material: HIMACS S029 Ivory White
 Photographer: Enzo Orlando





A bold hello

Architects love reception counters and bars – and so do hotel guests. The freedom to play with form provides the opportunity to make especially creative (design) statements with HIMACS.

Where good taste is at home

The new headquarters of Scotland's oldest coffee roaster is full of life. The combination of HIMACS in sleek Ultra Dark Grey and the warm honey tone of the oak interior makes the excellent coffee taste even better.

THOMSON'S HQ

Location: Glasgow, Scotland
Design: Technique Architecture & Design
Fabrication: Silo Design & Build
HIMACS Supplier: James Latham
Material: HIMACS S924U Intense Ultra Dark Grey
Photographer: ZAC and ZAC



Emser Thermenhotel

Location: Bad Ems, Germany
Architects: 4a Architekten GmbH
Fabrication: Appia Contract GmbH
Material: HIMACS M605 Sanremo
Photographer: David Matthiessen Fotografie



The super casual HIMACS bar in HIMACS Dark Night is the secret star of the Brooklyn Hotel. HIMACS also shines in the reception areas. In the 191 washrooms HIMACS was the material of choice, in Alpine White S028, for the sinks.

Hotel Brooklyn Leicester

Location: Leicester, United Kingdom
Design: Squid-inc
Fabrication: Whitehall Fabrications and Deanhouse Interior
HIMACS Supplier: James Latham
Material: HIMACS, S111 Dark Night and S028 Alpine White
Photographer: Jeremy Rata Photography

Furniture and Product Design

A material either inspires a designer or it doesn't. HIMACS makes the creative even more creative. And does what it says it will do.

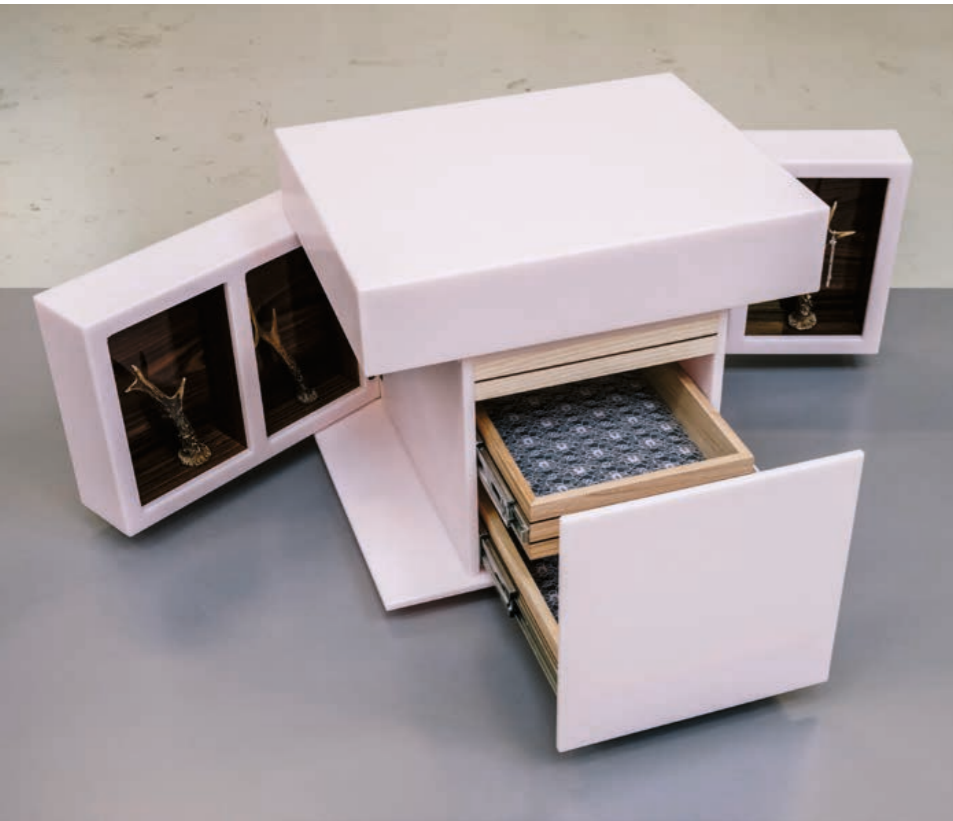

It's just a simple pink cube at first glance. Upon closer inspection, it reveals itself to be a multi-functional unit with compartments, drawers and hinged doors. It's great that HIMACS can be processed so precisely, keeps its shape over decades and gives the object the solid, high-quality design it needs.

La Perla Rosa

Location: Maasdijk, The Netherlands
Design: Bart van den Berg
Fabrication: Bart van den Berg
HIMACS Supplier: Baars & Bloemhoff
Material: HIMACS S304 Ruby
Photographer: Willy Lamers

It's the details that make a product. HIMACS forms the housing of this modern espresso machine. The skilfully moulded sides gives this designer piece its chic charm.



MARO Model 1

Location: Suhl, Germany
Design: Bojidar Djenev, Bulgaria
Fabrication: Interiors manufacture & design
Material: HIMACS Ultra-Thermoforming S928 Alpine White
Photographer: Paul Traeger – Fotoloft Erfurt

This table, designed in the chic Bauhaus style, is a virtual icon. The round tabletop and substructure are made of stable 12 mm panels in HIMACS Sapphire.

Apartment VA8 Furniture

Location: Cascais, Portugal
Design: DC.AD
Fabrication: Acrylic Stone by Horta & Verissimo
HIMACS Supplier: Banema S.A.
Material: HIMACS S303 Sapphire
Photographer: Francisco Nogueira



When young designers get their hands on HIMACS, they generally get creative with it. The material, here in bright orange, practically begs to be turned into interesting shapes. This award-winning design is the perfect showcase of the creative possibilities.

Rycotewood Design Contest 2022

Location: Oxford, United Kingdom
Design & Fabrication: Yuchen Liu
HIMACS Supplier: James Latham
Material: HIMACS S027 Orange
Photographer: Josh Cameron, Feed Me Content

This elliptical sideboard has a style reminiscent of a striking mid-century design. The bold shape of the storage compartments is created by the three-dimensional formability of HIMACS.

TV-dressoir

Location: Rotterdam, The Netherlands
Design: Daan Janssen
HIMACS Supplier: Baars & Bloemhoff
Material: HIMACS S028 Alpine White
Photographer: Willy Lamers



HIMACS has the competitive edge in this segment: it is the material of choice thanks to its purity, sterility and internationally certified resistance to dirt, viruses, bacteria and a number of chemicals.



Dental clinics are places with high hygiene requirements. HIMACS is an especially good choice here thanks to its functional benefits. The main objective of this impressive back wall, however, was to visually express the concept of cleanliness.

Two different shades of white were seamlessly connected to create the vertical bars, making the wall look like it is always illuminated.



Dental Clinic Pedroche

Location: Madrid, Spain
Design: Yolanda Segade - Segadestudio arquitectura interior
Fabrication: AR Superficies Solidas
Material: HIMACS S028 Alpine White
Photographer: Estudio Paloma Pacheco

HIMACS. When hygiene is the top priority

Expertise: HIMACS in hospitals, medical practices and laboratories

Especially suitable for decontamination of dangerous viruses such as HIV-1 and SARS-CoV-2



Resistant to bacteria



Resistant to chemicals

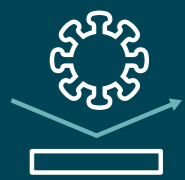

Resistant to viruses

What makes HIMACS especially hygienic

Certified hygiene: HIMACS is internationally certified* as resistant to mould, dirt, viruses, bacteria and a number of chemicals.

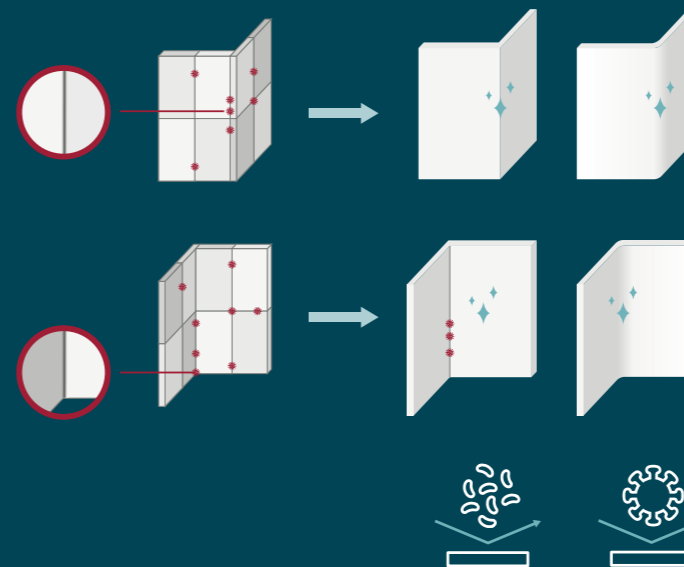

- Seamless, easy-care craftsmanship: HIMACS has a smooth and non-porous surface that does not allow liquids and germs to get in. The seamless finish prevents bacteria or mould from setting in. Quick and thorough cleaning means that cross-contamination and contact-transmission germs have no chance.
- UV-C cleaning: the UV-C method is a disinfection procedure that utilises UV radiation. It kills micro-organisms like germs, viruses and bacteria quickly and effectively. The unique properties of HIMACS-UV+ S828 allow the use of this highly effective method.
- Chemical resistance: household chemicals or aggressive disinfectants for operating theatres: HIMACS can handle the strongest of cleaners and still look like new.
- Function meets design: flexible formability and a wide range of colours to choose from mean that HIMACS offers excellent design possibilities and still meets all the prerequisites for a sterile environment.

*certified by an independent laboratory in accordance with international LGA and NSF standards



Dental Surgery's Practice

Location: Freiburg, Germany
Design: Mann Möbel GmbH
Fabrication: HKS Design
Material: HIMACS S028 Alpine White
Photographer: Jessica Alice Hath

Relief milling technology makes large-scale lighting effects possible. The design – in this case, the logo and a thin vertical line – are routed on the back side. The deeper the milling, the brighter the lighting effect. The benefit of this approach is that the front side remains smooth and can be cleaned quickly and thoroughly.

Dental Surgery Casa Dentalis

Location: Berlin, Germany
Design: Raum 11 GmbH
HIMACS Supplier: Klöpfer Surfaces
Material: HIMACS S029 Ivory White
Photographer: Raum 11 / Annett Möller



That famous first impression

This reception desk in a doctor's practice has curved contours that lend it a very sympathetic, almost cute/cosy impression. The workstation is cut into the material to create this shape, with a mounted shelf. This is the natural result of good collaboration between the architect and the processor.

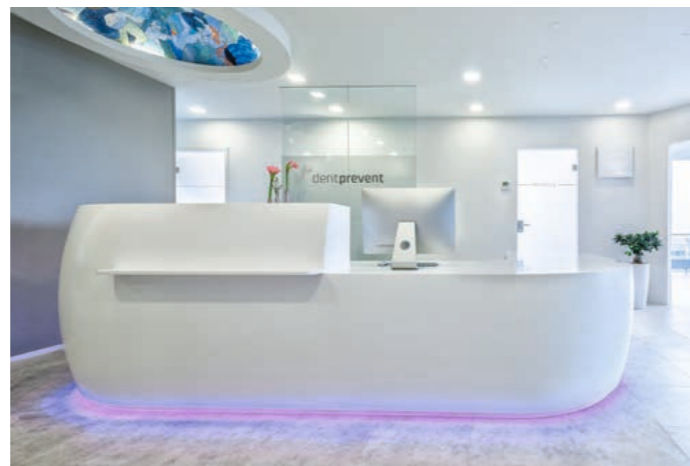

When hygiene counts, HIMACS is the answer

Cleaning and maintenance are top priority in today's medical practices. The non-porous, seamless finish of HIMACS and easy cleaning mean that the material is at home in a number of practices and clinics.



The Lucent collection gives its own very gentle impression. The special light refraction of the colours – in this case, Emerald – gives every room something mystical.



Doctor's Practice

Location: Berlin, Germany
Design: Raum 11 GmbH
HIMACS Supplier: Klöpfer Surfaces
Material: HIMACS S305 Emerald
Photographer: Raum 11 / Annett Möller

Doctor's Practice

Location: Cottbus, Germany
Design & Fabrication: Geilert GmbH
HIMACS Supplier: Klöpfer Surfaces
Material: HIMACS S028 Alpine White
Photographer: René Jungnickel



Living Spaces

In one's own home, the requirements for a material are very personal. And they are usually very complex. HIMACS brings the visual wow factor, is pleasant to the touch and is easy to maintain. So, welcome home!



HIMACS in the Babylon Beige finish appears across the entire length of the bathroom worktop, with two integrated sinks – also in HIMACS – and the lower unit in larch.

The basin of both sinks features a special inner shelf that serves as an additional storage area for soap and accessories.

TV House

Location: Affligem, Belgium
Design: Bruno Vanbesien Architects
Material: HIMACS S028 Alpine White, S120 Babylon Beige
Photographer: Tim Van De Velde

The minimalist kitchen island is streamlined down to the essential elements, which underscores the beauty of the HIMACS workstation.



Reduced to the max

The exclusive detached home in Affligem, Belgium, owes its name to its striking exterior contour. Minimalist shapes and premium materials dominate the interior. All surfaces in the kitchen and bathrooms were made from HIMACS. The seamless surface prevents the build-up of dirt, germs and bacteria and is easy to clean and therefore especially durable.



The geometry of luxury

The angular kitchen island sits at the heart of this luxury villa in Marbella. The clear, triangular tabletop and dynamic lines give a maritime vibe. The hob and sink are seamlessly integrated: it does not take much imagination to see that working and cooking together here would be a joy.



The fronts of the drawers are also made of HIMACS. Visually, this creates a compact, almost-closed unit.

Cool Blue Villa

Location: Marbella, Spain
Design: 123DV
Fabrication: Culimaat
Material: HIMACS S028 Alpine White
Photographer: Culimaat

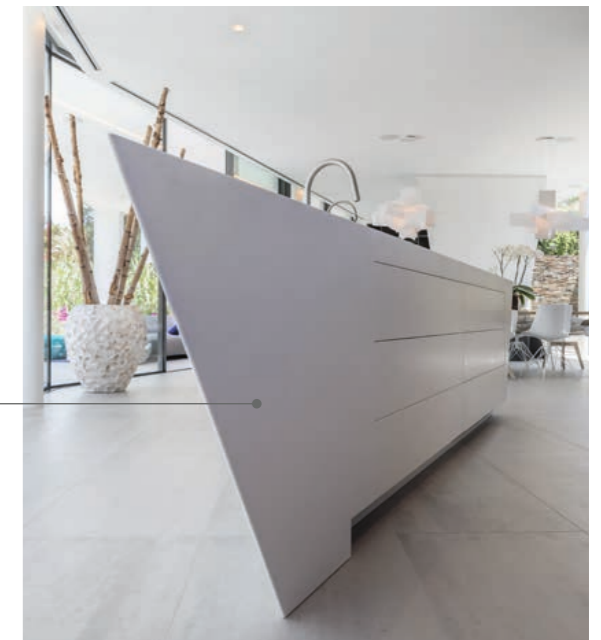

Kitchen

Non-porous, dirt-resistant, food-friendly surfaces. Flush-mounted sinks. HIMACS in the kitchen is fun, and it just makes sense.



Kievietdwarstraat

Location: Utrecht, Netherlands
Design: Paul Noordijk
Fabrication: Aimeubel, Michiel van den Brandhof
HIMACS Supplier: Baars & Bloemhoff
Material: HIMACS S203 Sky Blue
Photographer: Miranda Koopman

The historic cellar vault boasts the same impressive dimensions as the kitchen. Here's an exciting idea: this movable chopping board can navigate the whole length of the worktop.

Kitchen Vineyard France

Location: Aumelas, France
Design & Fabrication: Nicolas Yazigi
HIMACS Supplier: Planacryl
Material: HIMACS S028 Alpine White
Photographer: Nicolas Yazigi



By day it is an impressive kitchen island in a striking colour. By night, it brings a true WOW factor thanks to the unbelievable translucency of emerald from the Lucent Collection.



Popular colour: Sky Blue

Sky blue in the kitchen? Sounds unusual, but it looks gorgeous. In this kitchen, all functional units, including the cooking island, are completely made of HIMACS: work surfaces, wall cladding and cabinet fronts were manufactured in Sky Blue. Classy!



House on the shore of Lake Constance

Location: Lake Constance, Germany
Design: Stephanie Thatenhorst
Fabrication: Werkkollektiv GmbH
HIMACS Supplier: Klöpfer Surfaces
Material: HIMACS S305 Emerald
Photographer: Markus Burkhardt

Standalone appearance in XL



This kitchen presents a generous and casual approach. You can see yourself cooking with friends around the hob, working at the sink and prep station and then later relaxing at the large oak table. The durability of HIMACS was a decisive factor in this relaxation exercise.

One of the many wonderful HIMACS details is the hidden outlet plugs.

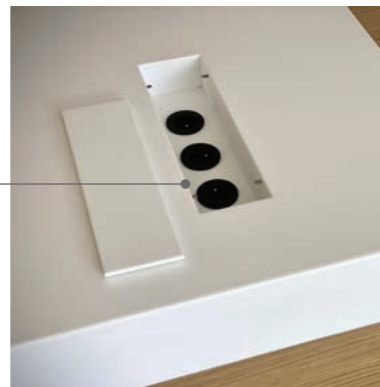

Private Kitchen Gold

Location: St Georges d'Orques, France
Design & Fabrication: Nicolas Yazigi
HIMACS Supplier: Planacryl
Material: HIMACS S028 Alpine White
Photographer: Nicolas Yazigi



Shiny copper, matt white. Perfect harmony

The angular design, large surfaces, skilful combination of two precious materials: metal and HIMACS. HIMACS can be used anywhere where kitchen work calls for durability and easy cleaning.

Luxury kitchen with copper fronts

Location: Susteren, The Netherlands
Design: Opstals Interieurmakers
Fabrication: Cora Techniek / Opstals Interieurmakers
HIMACS Supplier: Baars & Bloemhoff
Material: HIMACS S028 Alpine White
Photographer: Wouter van der Sar

Intelligent solution: the seamlessly integrated hand towel holder.

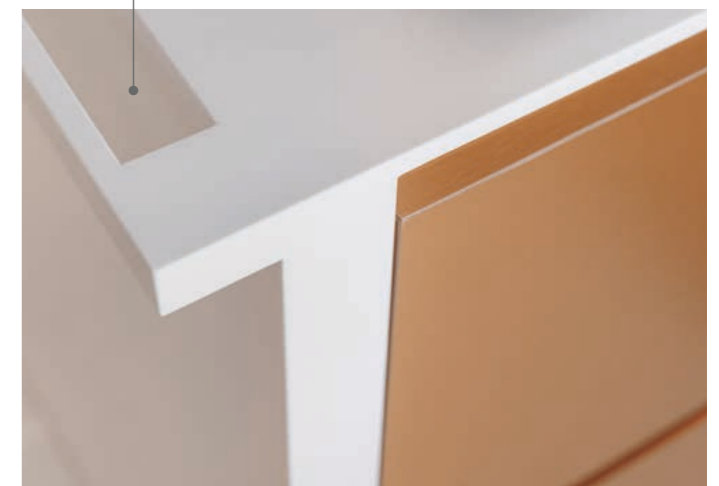

Bathroom

HIMACS and water: perfect together because HIMACS is homogeneous and waterproof. The huge selection of high-quality sinks makes the decision easier.

Peace and harmony



The entire shower and bath area is designed as one generous unit, with well-thought-through details such as how the cut-outs in the back wall of the shower help guide the geometric installation.

Private Bathroom ADJ

Location: Strasbourg, France
Design: Sophie Clément C-So Design
Fabrication: ADJ
HIMACS Supplier: Aska Interior
Material: HIMACS G101 Crystal Beige, S028 Alpine White
Photographer: Vincent Eschmann



Small but perfect

Small rooms are often a challenge. This sink makes the most of the space thanks to the armature on the side. The complete sanitary range of furniture is made from HIMACS and was completely customised.

City Apartment Amsterdam

Location: Amsterdam, Netherlands
Design: Project from I + Y Interior Architecture, basin Base from Not Only White in S028 Alpine White
Material: HIMACS S028 Alpine White
Photographer: Barbara de Hosson



Classy hand washing

It's small but rather cool. This unit in a disabled toilet in Manchester makes a big impression despite its compact size, with the straight lines of the sink in white and all functional parts in copper.



NOMA Manchester

Location: Manchester, United Kingdom
Design: The Splash Lab
Architect: Simpson Haugh Architects
Material: HIMACS S028 Alpine White
Photographer: Simone Morciano

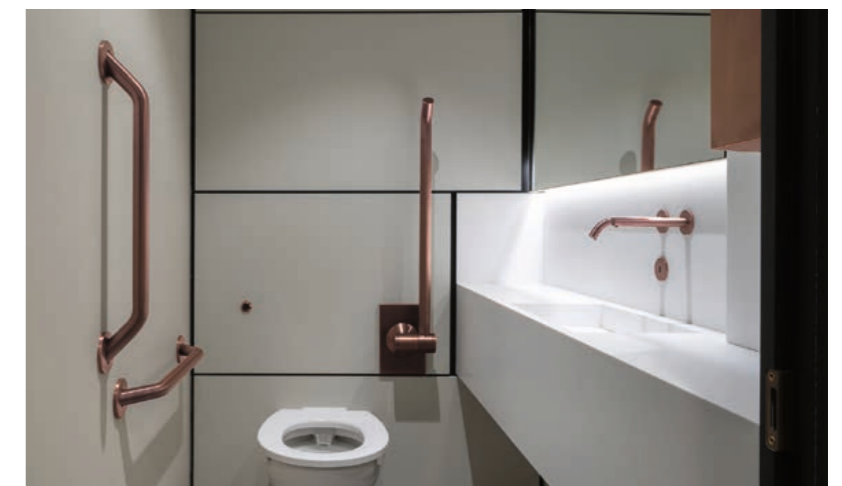

Airport

Extreme and constant traffic from travellers and staff calls for the simple cleaning and high durability of HIMACS, possible thanks to the innovative Thermalcure technology.



Apparently, Lufthansa likes HIMACS. The elegant, durable material was selected for the lounge at Milan Airport, covering the counters, wall cladding, tables and the impressive wall-to-wall bookshelves.

Milan Airport Lufthansa Lounge

Location: Milan, Italy
Design: Kitzig Interior Design GmbH
Fabrication: Baierl&Demmelhuber Innenausbau GmbH
Material: HIMACS S028 Alpine White, G108 Lunar Sand
Photographer: Deutsche Lufthansa AG – Christian Laukemper



Transport and Marine

These are compact, highly functional units. Made with “fireproof and fire-retardant properties”. HIMACS FR was designed for the ship-building industry and includes modules B and D of the IMO certification.



RoadXplorer

Location: Wolfersdorf, Germany
Design & Fabrication: Beer GmbH
HIMACS Supplier: Klöpfer Surfaces
Material: HIMACS S102 Babylon Beige
Photographer: Beer GmbH



On the road to heaven

Adventurers definitely need reliable companions. The flooring of the RoadXplorer is completely made of HIMACS in a geometrical design. It looks great... and stable.

Note: indoor-outdoor lounge ahoy!



Yacht EVO V8

Location: Italy
Design: Shipyard: Blu Emme Yachts S.R.L. Italy
Material: HIMACS Alpine White
Photographer: Studio Borlenghi

The EVO V8 is literally the new flagship of Italian yacht manufacturer Blu Emme Yachts. Impressive in every way. The lounge area is between the indoor and outdoor space. Simply open the large sliding door to extend the space out into the outdoor area. Even the corner bar, with a small sink integrated in the workspace, is made of HIMACS.



This compact but clever kitchen unit on a yacht was designed with life at sea in mind: the high surge edge prevents liquids from the dripping or running off of the work surface. It is very easy to realise with HIMACS.

Y7 MODEL

Design: YYachts
Material: HIMACS S006 Arctic White
Photographer: YYachts



Maximum functionality in the smallest space: a perfect, seamless finish makes for a compact working unit in this kitchenette.

Y8 MODEL

Design: YYachts
Material: HIMACS G557 Cloud Concrete
Photographer: YYachts



E-mobility wall box

Location: Friedberg, Germany
Design & Fabrication: fischer-aic GmbH
HIMACS Supplier: Klöpfer Surfaces
Material: HIMACS S212 Light Green
Photographer: Wilson Ortiz



The designers of this wallbox chose HIMACS, once again because of the durability and quality it offers for outdoor use. The wonderful, mystic light reflection from HIMACS and the meaningful colour Light Green also helped.

All Time Favourites

In recent years, HIMACS has been commissioned by architects and designers. Thanks to their skill and talent and the outstanding quality of material and workmanship, they created some masterpieces with HIMACS. Great classics that still inspire us today.

Leonardo Glass Cube

Location: Bad Driburg, Germany
Design: 3deluxe, Germany
Fabrication: Rosskopf & Partner AG, Germany, www.roskopf-partner.com
Material: HIMACS Alpine White
Photographer: from left to right – 3deluxe and Emanuel Raab



The atmospheric and open Brandworld by glass manufacturer Leonardo was designed by 3deluxe in 2007 and is still an icon of the futuristic yet amorphous design language. The decisive factor: the thermoformability and invisible connection of HIMACS. Inside and out.

19 well-known architects and designers designed this hotel – naturally using HIMACS. The result of their work is simply breathtaking, with every room being a veritable stand-alone masterpiece. HIMACS was with them every step of the way – inspiring the designers to create their most daring designs.

Hotel Puerta America

Location: Madrid, Spain
Design & Fabrication: from left to right: Christian Liaigre, France, christian-liaigre.fr – Ron Arad, UK, ronarad.co.uk – Zaha Hadid Architects, UK, zaha-hadid.com
HIMACS Supplier: Klöpfer Surfaces
Material: HIMACS Alpine White, Black, Fiery Red
Photographer: diephotodesigner.de

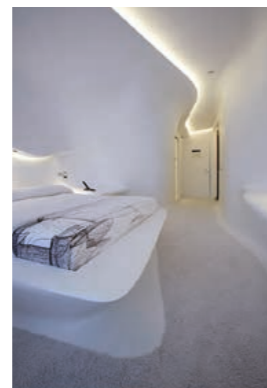

When design and art merge, spaces are created that communicate emotionally. In this beautiful bar, both have combined to create a masterpiece. The customers become part of the stage and revel in the fabulous art deco surroundings with the dramatic lighting effects. HIMACS is a crucial building block for this quality of experience: magical translucency, soft feel and the complete package of good gastronomic properties.

Bar Paradise Now

Location: Düsseldorf, Germany
Design: Moritz von Schrötter, Charles Bals, Walid El Sheikh
Fabrication: Schreinerei Karl Heller GmbH, Germany, schreinerei-heller.de
HIMACS Supplier: Becher GmbH & Co. KG
Material: HIMACS Ispani, Arctic White, Black
Photographer: Rainer Rehfeld



The Raiffeisen Bank in Zurich displays the portraits of former prominent residents that catch the eye thanks to the intricate design made of triangles of different sizes and the spartan overall interior.

Raiffeisen Bank Zürich

Location: Zurich, Switzerland
Design: NAU Architecture, Switzerland, Drexler Guinand Jauslin Architekten, Switzerland, nau.coop, dgj.ch
Fabrication: Wallcovering patterns design: ROK, Rippmann Oesterle Knauss, Switzerland, rok-office.com – Wallcovering and joinery: Glaeser Baden, Switzerland, glaeser.ch
Material: HIMACS Alpine White
Photographer: Jan Bitter



HIMACS has a sensuous way of dealing with light: When used as a facade the material provides great aesthetic properties. The light is absorbed or reflected, depending upon the intensity and angle of incidence, and gives the Sokcho Housing in Alpine White a mystical feel.

Sokcho House in White

Location: Inheung-ri, Toseong-myeon, Goseong-gun, Gangwon-do, South Korea
Design: Woo-jin, LIM AEV Architectures
Material: HIMACS Alpine White
Photographer: AEV Architectures



What makes the HIMACS sheet so special

Our HIMACS sheet is the perfect basis for your ideas. For different applications and areas, there are special thicknesses and dimensions and also some special material compositions.

Sheet Material

- HIMACS is available in different thicknesses, formats, and sizes. Perfect for maximising cuts and minimising costs. However, not all colours are available in every thickness. See the table for availability below.
- HIMACS sheet material is available in thicknesses of 4.5 mm, 6 mm, 9 mm, 12 mm and 20 mm as well as the corresponding sheet formats.

HIMACS is also available in special formulations

- HIMACS Exteria®: HIMACS FR – Low flammability, ETA Certified, IMO Certified, Norm EN 45 545 Class R1 HZL3 for fire protection on railway vehicles.
- HIMACS UV+ – Advanced UV resistance.
- HIMACS Ultra-Thermoforming: Advanced Thermoforming, up to 6 mm internal radius.
- HIMACS Intense-Ultra: The best of two worlds – Ultra-Thermoforming and Intense Colour Technology

For more information, see page 52 – 67.

Standard Formats

2490 mm	3000 mm	3680 mm	
[Sheet]	[Sheet]	[Sheet]	760 mm
[Sheet]	[Sheet]	[Sheet]	910 mm
	[Sheet]	[Sheet]	930 mm
	[Sheet]	[Sheet]	1350 mm
		[Sheet]	1520 mm

Dimensions – Sheet material

Standard Format

Standard formats are available in stock, for specific thicknesses per colour, please refer to the colour chart on page 52 – 67, or contact your sales representative.

SHEET THICKNESS IN MM	SHEET LENGTH IN MM	SHEET WIDTH IN MM
4.5	3000*	930
6	2490	760
	2490*	910
	3680*	1350
9	3680	760
	3680*	910
	3680*	1350
12	3680	760
	3680*	910
	3000***	1350
	3680*	1350
20	3680*	1520
	3000	760

Ultra-Thermoforming Format

SHEET THICKNESS IN MM	SHEET LENGTH IN MM	SHEET WIDTH IN MM
12	3680**	760
		930
		1520

- * Only available in S028 Alpine White.
- ** Only available in S928 Alpine White.
- *** Only available in Opal

If needed, LX Hausys Europe can produce different dimensions (as well as bespoke colours). To learn more about the conditions, please contact us at lxhausys.com/eu

Life becomes so much more colourful with HIMACS



Photographed by © Petr Krejčí

Gravilla

NEW
COLLECTION

The Collections

Explore the Spectrum:
Our Signature Collections for
a World of Inspired Design.

Gravilla | Aurora and Marmo | Solids | Terrazzo |
Lucia | Concrete | Aster | Volcanics | Lucent |
Granite, Quartz, Sand and Pearl | Advanced Series |
Intense Ultra

Note:

The basic HIMACS material is identical for every colour but it is important to note that darker and more heavily pigmented colours will show dust, scratches, haziness, marks left by hard water and other ordinary wear and tear more noticeably than lighter textured colours.

Some HIMACS colours are particularly suitable for outdoor applications because of their good UV-resistance. HIMACS offers a 10 Year Warranty on colours' UV resistance and loss of gloss over 40%, 10 Year Warranty on colour leaching and 20 Year Warranty on colour peeling, swelling or delaminating.

The warranty is applicable after the first installation and is only valid for the sheet material; adhesives are excluded. The conditions for this warranty are based on practical experience and on-going tests.

Certain colours are also available in 20 mm upon special request, minimum quantities apply.

There may be deviations between the illustrated and actual colours owing to printing techniques. To receive the detailed colour range, please contact us at lxhausys.com/eu.

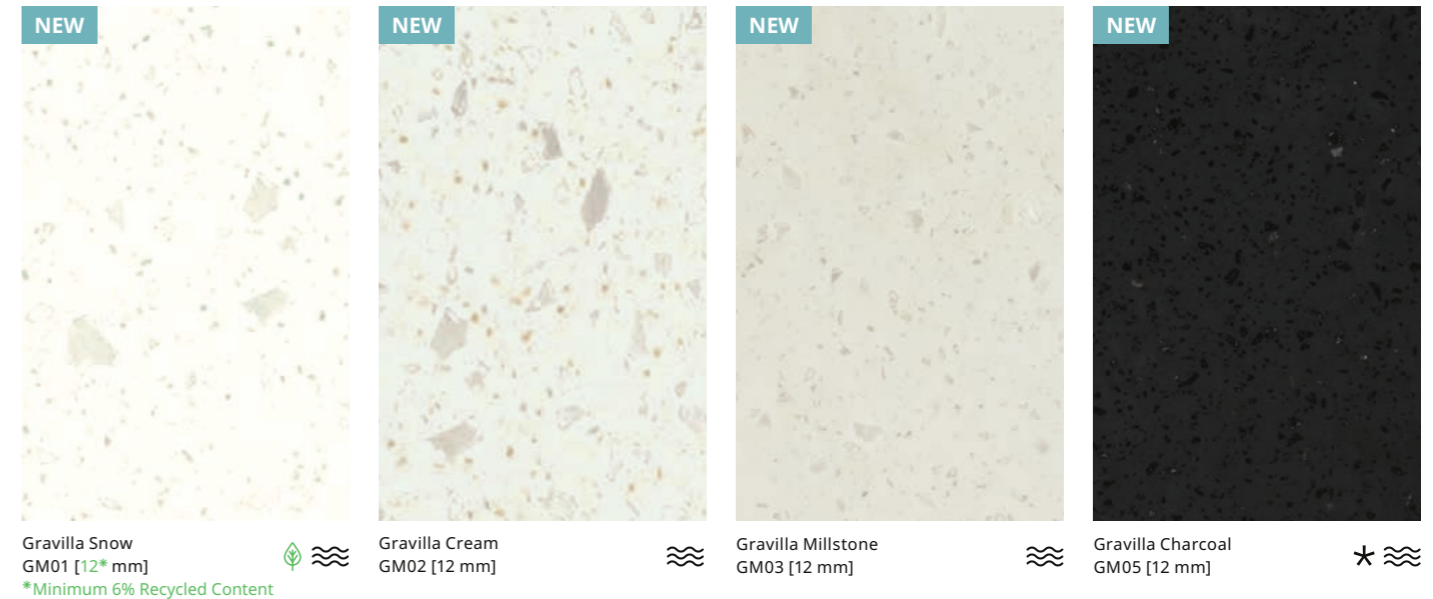

The Gravilla collection follows the aesthetic veined trend of Aurora & Marmo combined with a granite particles inspiration thanks to the shorter veins and a chip effect. The new Gravilla colours have the benefit of being easier to fabricate with seamless joining, ideal for large surfaces such as shower or wall cladding in a bathroom, long, wide islands in the kitchen or monolithic reception desks with big aesthetic impact.



★ Less suitable for surfaces which are subject to high traffic, due to their higher pigmented colour saturation, marks may be seen more easily.

* SCS certified pre-consumer recycled content only applicable to the indicated thickness.

⋈ As these are randomly veined colours, specific fabrication guidelines need to be followed. Ask your sales partner for more information or visit: lxhausys.com/eu.

Contains SCS certified pre-consumer recycled content.

Aurora and Marmo

6 NEW COLOURS

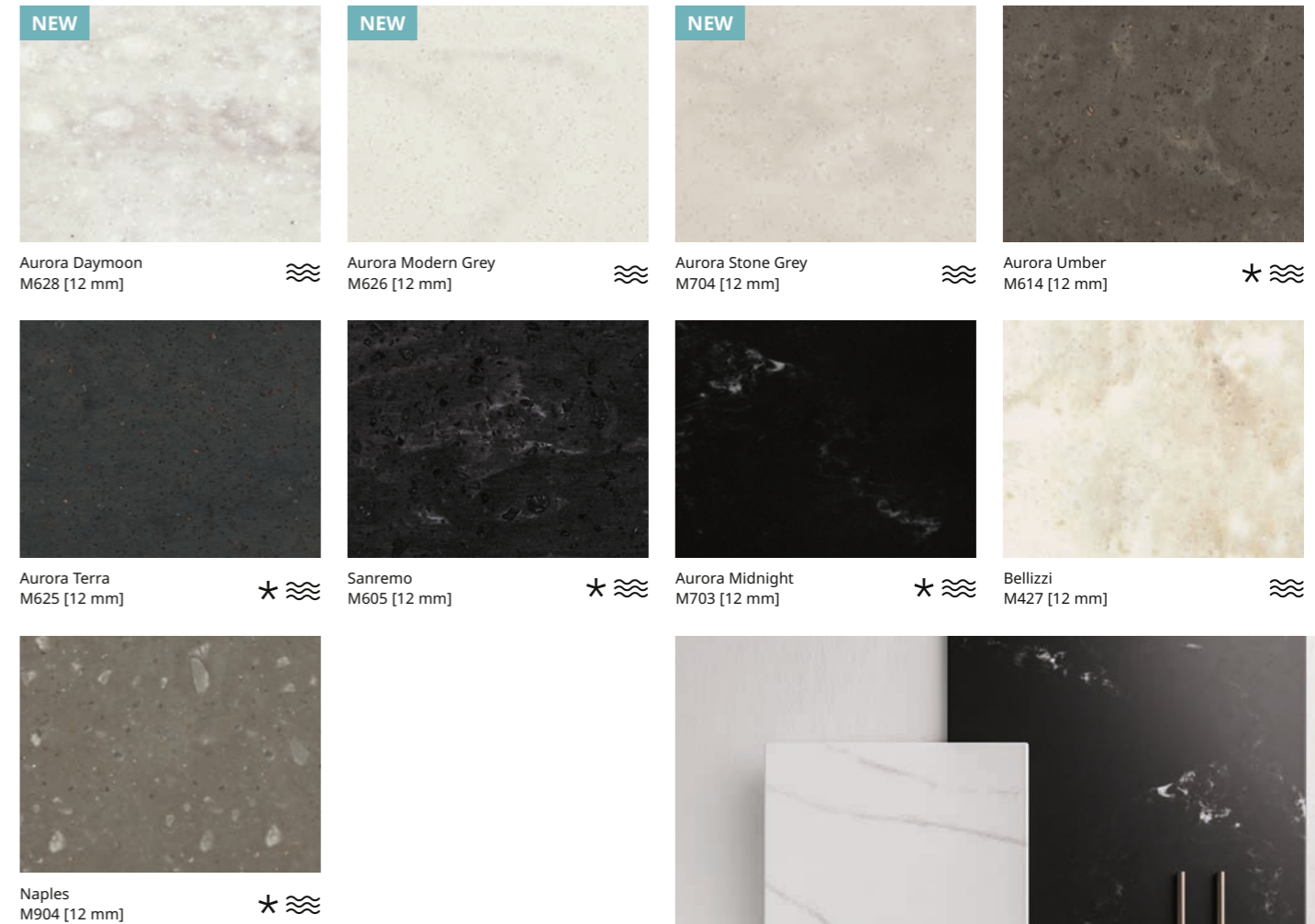
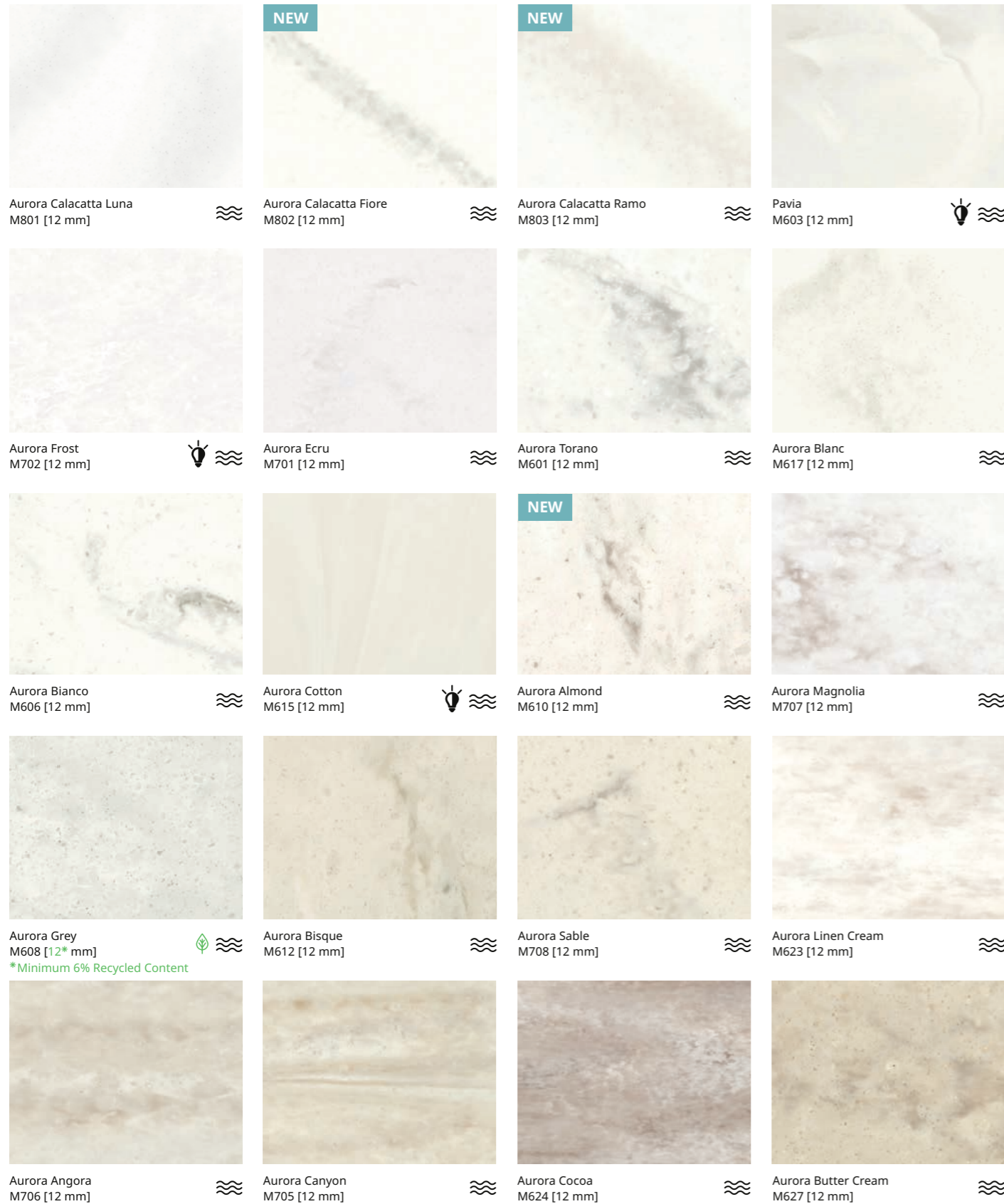

The HIMACS Aurora and Marmo Collection provides colours to address the current trends for top-quality marble aesthetics, ranging from semi-translucent white, through shades of grey, to striking dark brown and anthracite tones.

6 new Aurora colours – an evolution of the Marmo Collection – have been added to the range combining aesthetics inspired by nature with all the benefits of the latest generation solid surface HIMACS.

- ★ Less suitable for surfaces which are subject to high traffic, due to their higher pigmented colour saturation, marks may be seen more easily.
- ≈ As these are randomly veined colours, specific fabrication guidelines need to be followed. Ask your sales partner for more information or visit: lxhausys.com/eu.

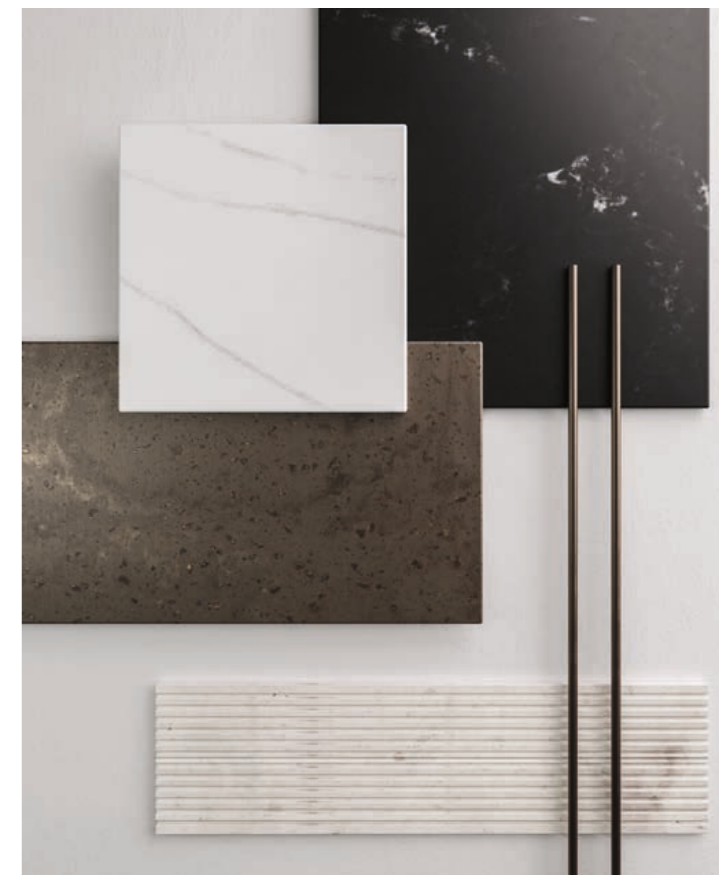

- † Colours with this mark have a semi-translucent effect, evident when combined with light sources.
- ♻ Contains SCS certified pre-consumer recycled content.

Solids

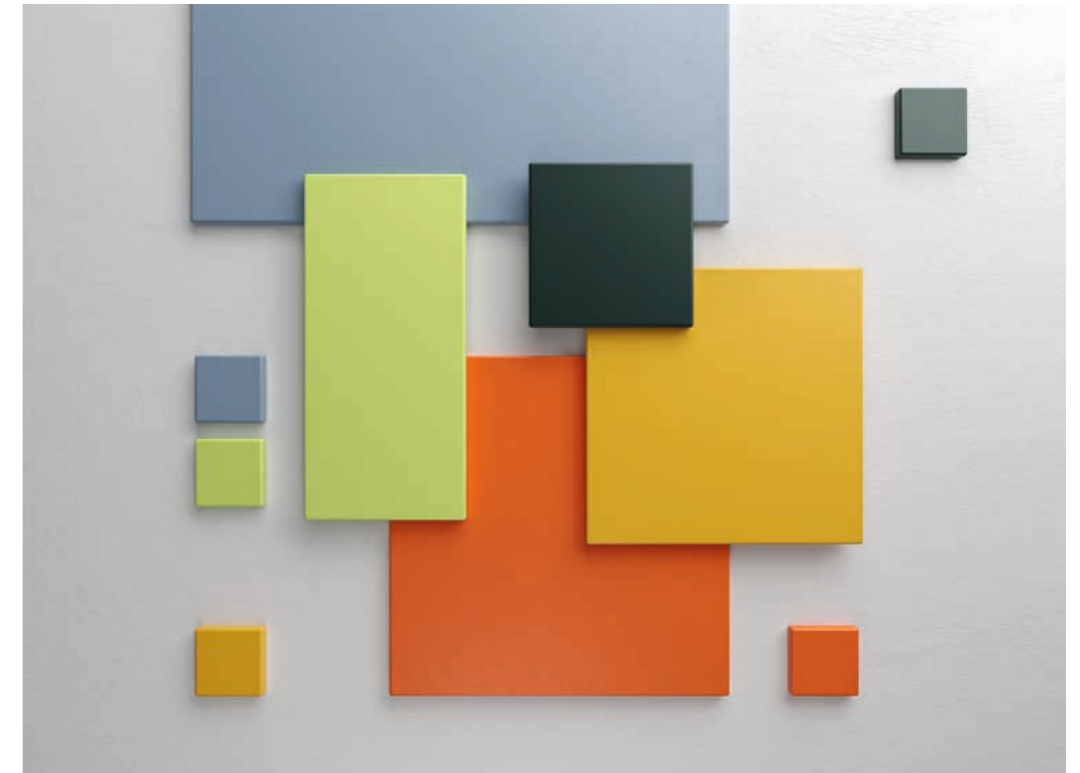
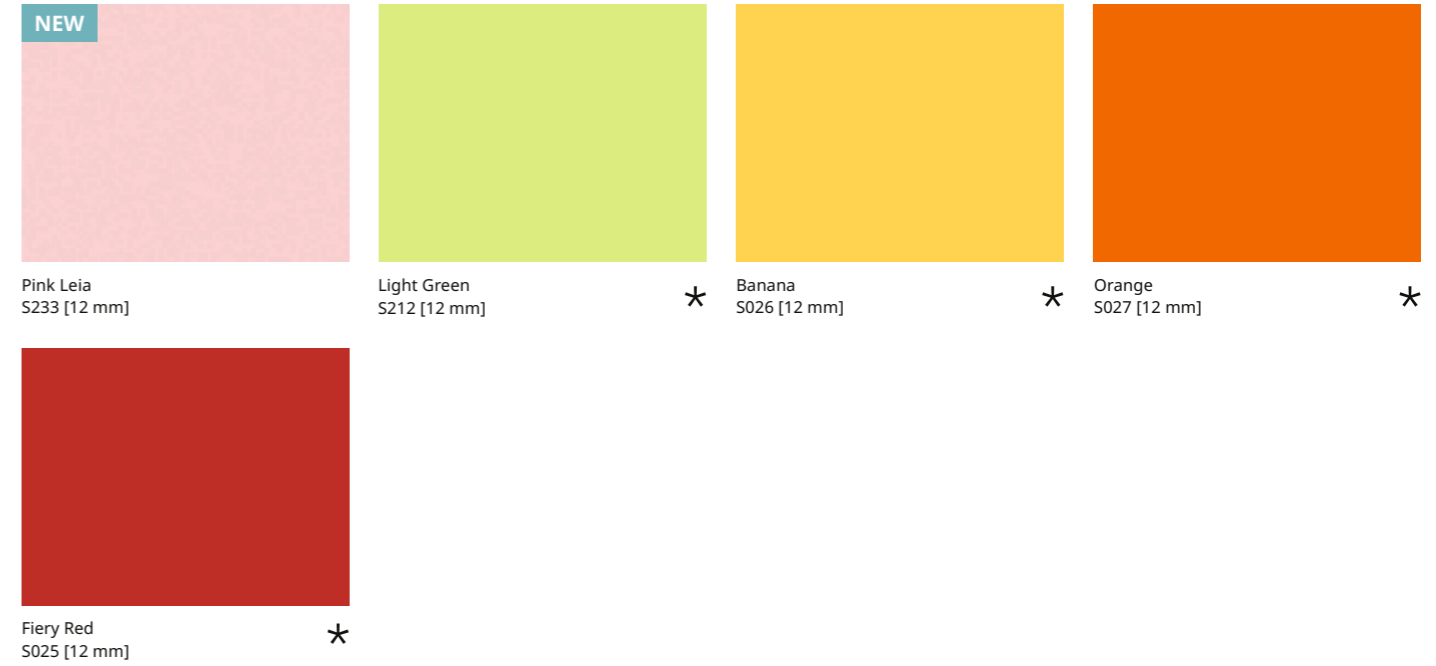

HIMACS solid surface is identical for every colour, although darker hues have a higher percentage of natural pigments, which need more careful care and attention. There may be some slight variation in colour between the illustrated and the sample due to printing techniques, colour may vary slightly from the sample.

Alpine White is also available in the special formulations S728 HIMACS-FR (Improved Fire Resistance) and S828 HIMACS UV+ (Improved UV resistance).

* SCS certified pre-consumer recycled content only applicable to the indicated thickness.

* Less suitable for surfaces which are subject to high traffic, due to their higher pigmented colour saturation, marks may be seen more easily.

☀ Suitable for exterior use. Please check conditions about level of suitability and warranty per colour.

ΔE5 Important information for outdoor use. These colours change of less than or equal to 5 ΔE units in 10 years under normally predictable circumstances.

♻ Contains SCS certified pre-consumer recycled content.

Terrazzo



Terrazzo has a long tradition as a material aesthetic: the coarse-grained look has offered the perfect blend of longevity and elegance since antiquity. HIMACS has now adopted the trend with two colours, which both combine perfectly with their typically coarse-grained, 'splattered' look. The Terrazzo Collection is especially suitable for the hospitality and gastronomy sector, as well as for any other high-traffic public building.



Terrazzo Classico
Q001 [12 mm]

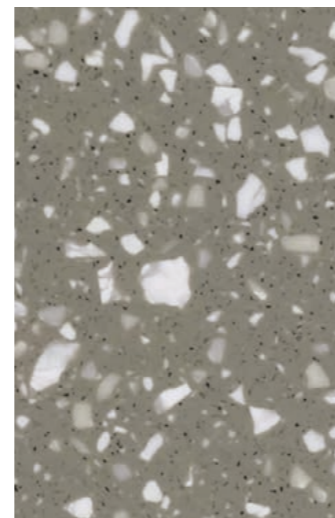

Terrazzo Grigio
Q002 [12 mm]

Lucia



Ice Queen
W001 [12* mm]
*Minimum 8% Recycled Content

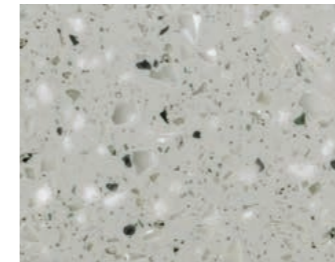

Shadow Queen
W003 [12* mm]
*Minimum 6% Recycled Content

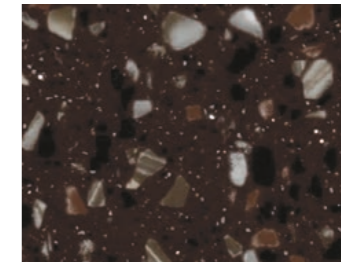

Red Quinoa
W010 [12 mm]

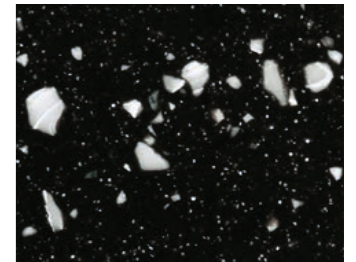

Star Queen
W004 [12 mm]

This exceptional collection focuses on lively and harmonious textures that infuse each hue with distinct character and expression. It's no wonder that three of these remarkable colours were created by the renowned Dutch designer, Marcel Wanders himself. Embrace the purity and sophistication of this

collection as it harmonises the classic appeal of black, white, brown and grey with a contemporary twist. With textures that breathe life into each shade, this collection captures the essence of timeless elegance and sets the stage for you to express your unique style and creativity.



★ Less suitable for surfaces which are subject to high traffic, due to their higher pigmented colour saturation, marks may be seen more easily.

👤 Design Collection by Marcel Wanders.

♻️ Contains SCS certified pre-consumer recycled content.

* SCS certified pre-consumer recycled content only applicable to the indicated thickness.

Concrete

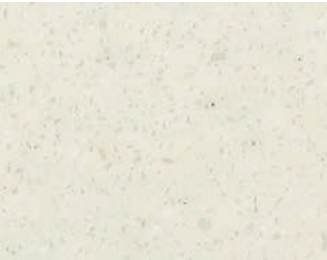

Snow Concrete
G556 [12 mm]



Cloud Concrete
G557 [12 mm]



Urban Concrete
G554 [12/6 mm]

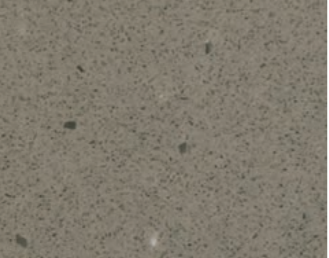

Steel Concrete
G555 [12/6 mm] *

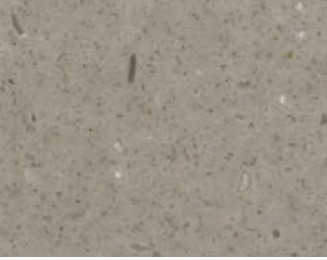

Chic Concrete
M551 [12 mm]



Shadow Concrete
M552 [12 mm] * ≈

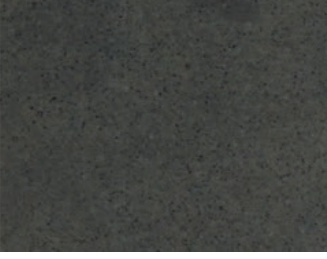

Ebony Concrete
M553 [12 mm] * ≈

* Less suitable for surfaces which are subject to high traffic, due to their higher pigmented colour saturation, marks may be seen more easily.

≈ As these are randomly veined colours, specific fabrication guidelines need to be followed. Ask your sales partner for more information or visit: lxhausys.com/eu.

The industrial look of concrete combined with the incredible flexibility of HIMACS. The Concrete Collection adds huge opportunities for great designs to architects and designers.



Aster



Nebula
T010 [12 mm]



Andromeda
T017 [12 mm]



Venus
T011 [12 mm]

Aster is a collection of sophisticated warm beige tones, varying from warm white to a captivating deep beige, all with a gorgeous mother of pearl shimmer.



Volcanics

The large particles of the Volcanics shades add a sense of style to any design. When used on a large scale the result is a dramatic showpiece. Three colours from the Volcanics range contain recycled content for an environmentally friendly solution with a luxurious natural stone look.

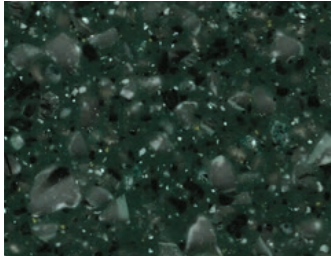

Maui
VG21 [12 mm]

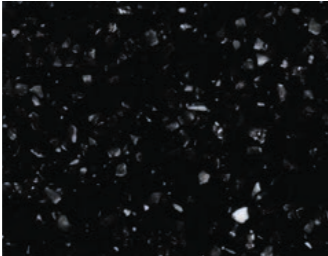

Cima
VB02 [12 mm]

✱

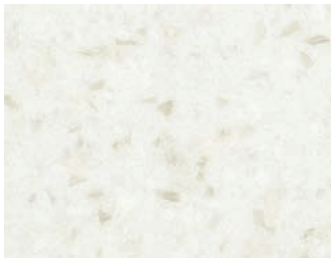

Gemini
VW01 [12* mm]
*Minimum 14% Recycled Content

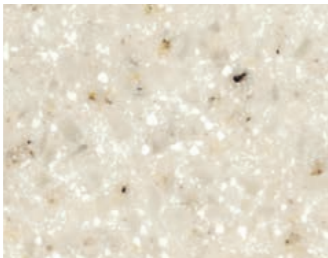

Tambora
VE01 [12* mm]
*Minimum 16% Recycled Content



Santa Ana
VA01 [12* mm]
*Minimum 13% Recycled Content



- ✱ Less suitable for surfaces which are subject to high traffic, due to their higher pigmented colour saturation, marks may be seen more easily.
- ♻️ Contains SCS certified pre-consumer recycled content.
- * SCS certified pre-consumer recycled content only applicable to the indicated thickness.

Lucent

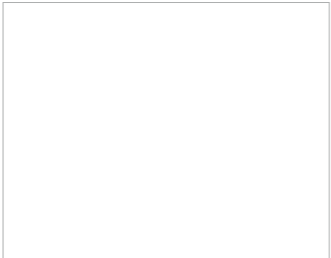

Opal
S302 [12/6 mm] | Δ E5

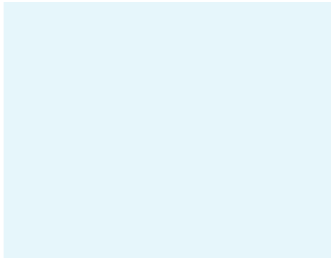

Sapphire
S303 [12 mm]

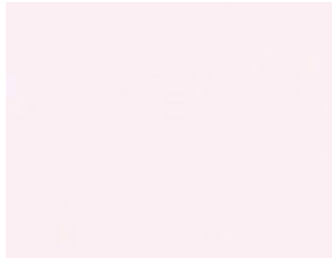

Ruby
S304 [12 mm]

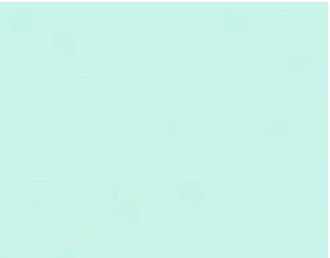

Emerald
S305 [12 mm]



When combined with precisely positioned light sources, the translucent pastel shades become transformed into dramatic design "highlights".

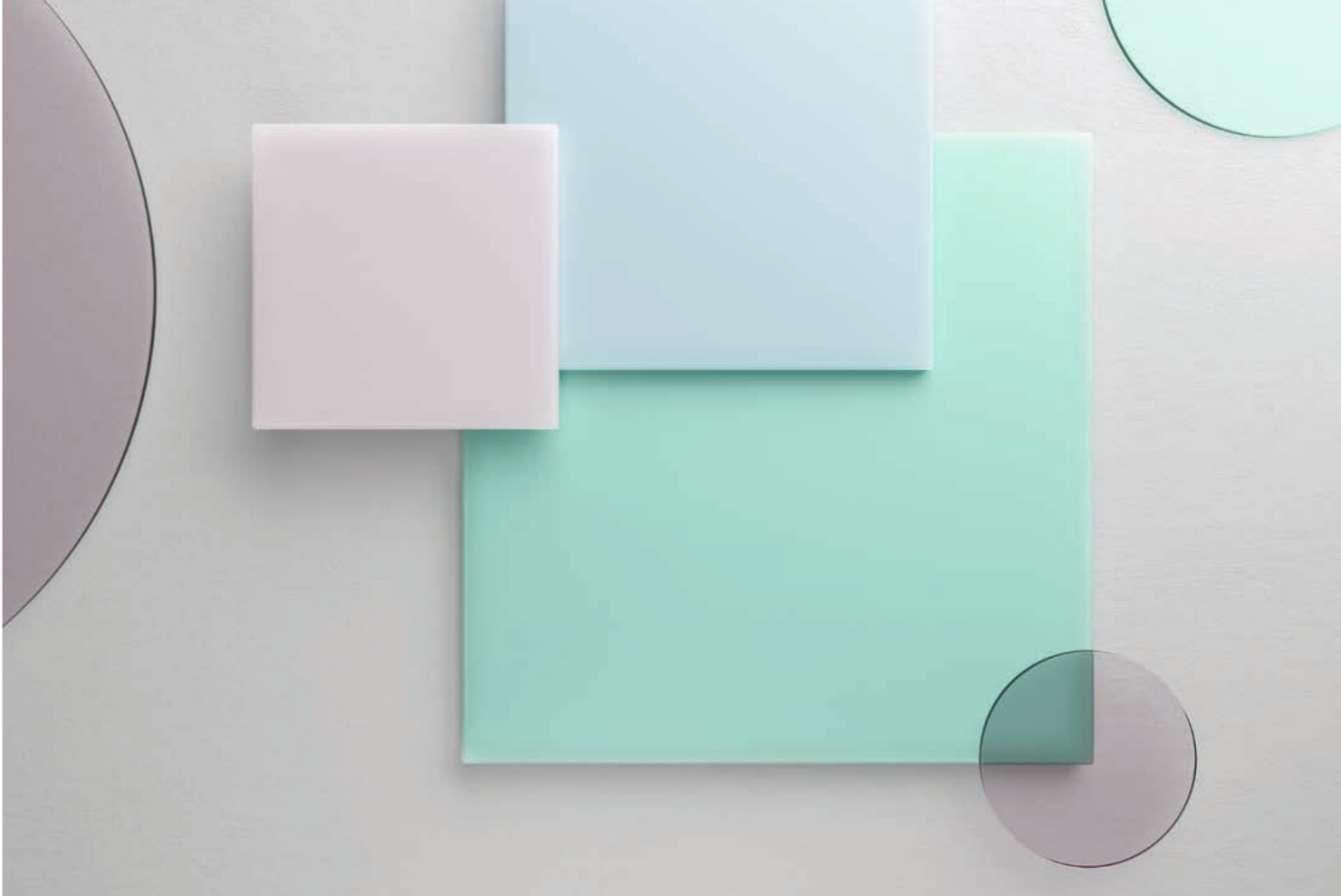





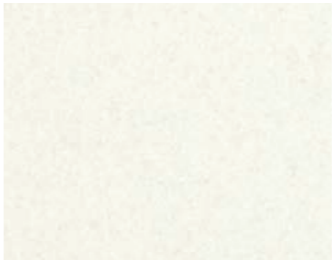

- ☀️ Suitable for exterior use. Please check conditions about level of suitability and warranty per colour.
- 💡 Lucent colours have a higher level of translucency, more evident when combined with light sources.

Granite, Quartz, Sand and Pearl

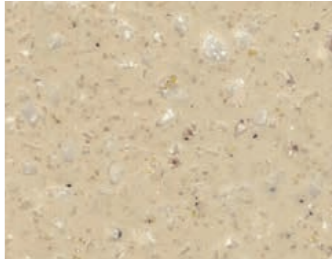
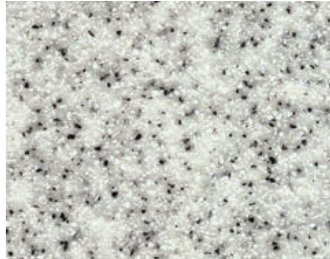
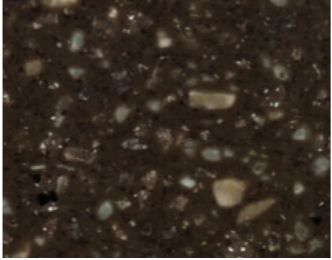
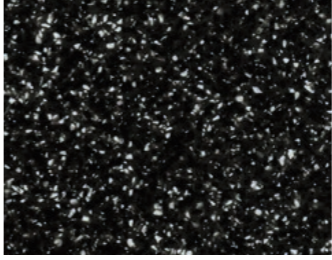

Ultimate elegance thanks to lively textures, harmonious natural tones and maximum subtleness. The Sand and Pearl, Granite and Quartz collections are perfect either alone or in combination with other colours.

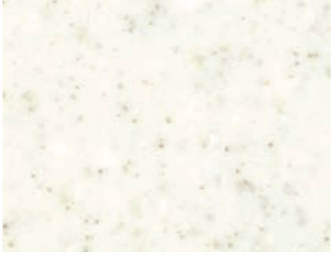
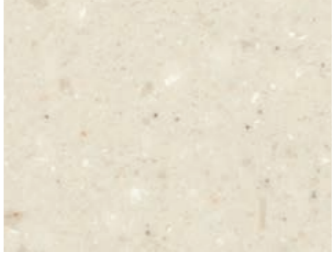
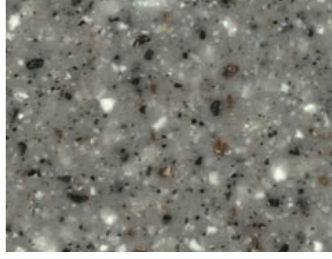
			
Arctic Granite G034 [12*/6 mm] Δ E5 *Minimum 7% Recycled Content	Lunar Sand G108 [12* mm] *Minimum 7% Recycled Content	White Quartz G004 [12*/6 mm] Δ E5 *Minimum 10% Recycled Content	Crystal Beige G101 [12/6 mm]
			
Sea Oat Quartz G038 [12 mm] Δ E5	Beach Sand G048 [12 mm] Δ E5	Peanut Butter G100 [12 mm]	Grey Sand G002 [12 mm] Δ E5
			
Mocha Stone G174 [12 mm]	Black Sand G009 [12 mm]	Black Pearl G010 [12/6 mm]	Black Granite G031 [12 mm]
			
Cotton Field G180 [12* mm] *Minimum 14% Recycled Content	Windy Hill G181 [12* mm] *Minimum 13% Recycled Content	Highland G183 [12* mm] *Minimum 12% Recycled Content	

- ☀ Suitable for exterior use. Please check conditions about level of suitability and warranty per colour.
- ★ Less suitable for surfaces which are subject to high traffic, due to their higher pigmented colour saturation, marks may be seen more easily.
- ♻ Contains SCS certified pre-consumer recycled content.
- * SCS certified pre-consumer recycled content only applicable to the indicated thickness.

Advanced Series

Special designs for special requirements: HIMACS Advanced Series

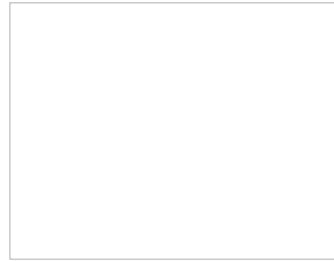

Alpine White
S728 [12 mm] | Δ E5



Low flammability: HIMACS-FR

The HIMACS-FR quality with reduced flammability is currently available in Alpine White S728 from the Solid Collection. HIMACS-FR has the fire protection classification “B-s1-d0” according to EN 13501 (Single Burning Item test (SBI test)). Fixed in place with KEIL anchors and a BWM construction, the HIMACS façade in S728 – Alpine White successfully passed the ETA tests (European Technical Agreement).

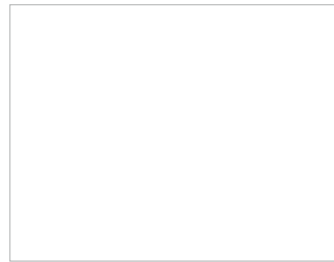

Alpine White
S828 [12 mm]



Optimal UV resistance: HIMACS UV+

HIMACS-UV+ S828 (Alpine White) is the new exterior formulation offering better UV resistance, which is particularly important when the façade is exposed to high levels of sunlight. In addition the formulation achieved FR in M1 France. Furthermore, the unique properties of HIMACS S828 UV+ allow for the use of the highly effective UV-C disinfection method, frequently used in the healthcare sector.

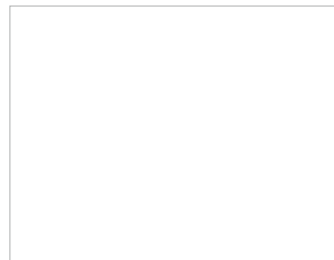

Alpine White
S928 [12* mm]



*Minimum 8% Recycled Content

Maximum formability: HIMACS Ultra-Thermoforming

Introducing HIMACS Ultra-Thermoforming: Redefine design with an innovative formula. Precision-crafted through advanced thermoforming, this cutting-edge product allows up to a 6mm minimum internal radius, offering unprecedented flexibility. Designers can create with freedom and embrace organic fluidity thanks to this revolutionary material that allows for more accentuated curves without compromising HIMACS' exceptional properties. HIMACS Ultra Thermoforming sheets are currently available in Alpine White S928 from the Solid collection.



Intense Ultra

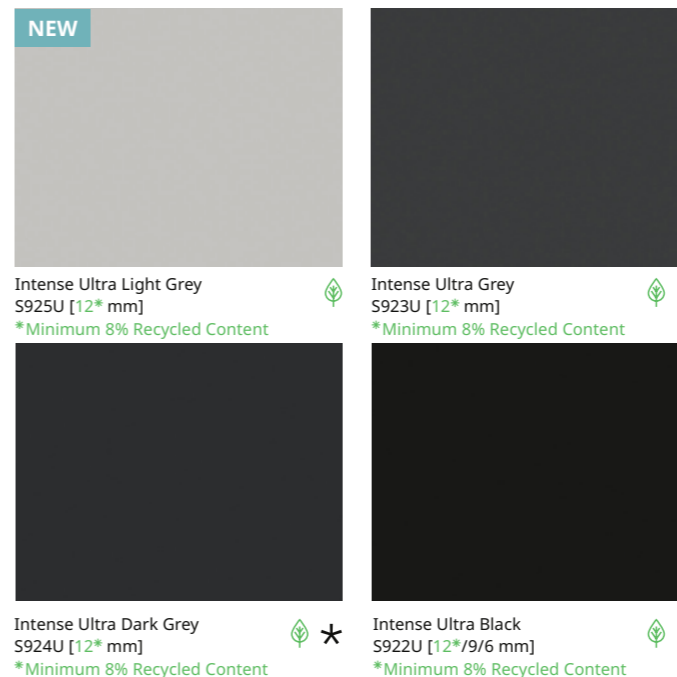

Small radii, intensive colouring: HIMACS Intense Ultra

HIMACS Intense Ultra combines intense colour technology with ultra-thermoforming. The effect: dark colours look even more intense, and the surface is significantly more durable and insensitive to scratching. HIMACS Intense Ultra can be moulded at a very lower internal radius of up to 6 mm without compromising on dark colours.

- 🌿 Contains SCS certified pre-consumer recycled content.
- * SCS certified pre-consumer recycled content only applicable to the indicated thickness.
- ☀️ Suitable for exterior use. Please check conditions about level of suitability and warranty per colour.
- ★ Less suitable for surfaces which are subject to high traffic, due to their higher pigmented colour saturation, marks may be seen more easily.

The Shapes

Sinks, wash basins, baths and shower trays made of HIMACS are perfect for the kitchen, lab or bathroom.

All of these products are designed so that they can be combined with HIMACS panels and be flush-mounted or installed underneath the panels – except for a couple of countertop basins for the bathroom.

The result is extremely hygienic, easy to maintain units from a single cast. Perfect for the bathroom, kitchen and laboratory. Individual custom-made products are also possible.

Sinks. Spacious and elegant.

**MOST
POPULAR**

CS404

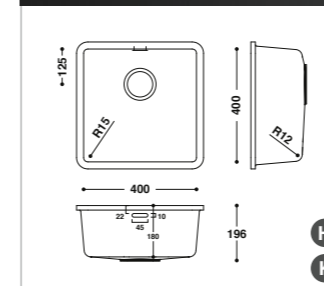

HIMACS Sinks for kitchen and healthcare applications

Spaciousness, durability and hygiene are all key quality features when choosing a sink for the kitchen or healthcare facility. The top quality models in the HIMACS range offer it all. These coordinated sinks are installed as undermounted creating extremely hygienic sink areas. Special custom-made creations are also an option.

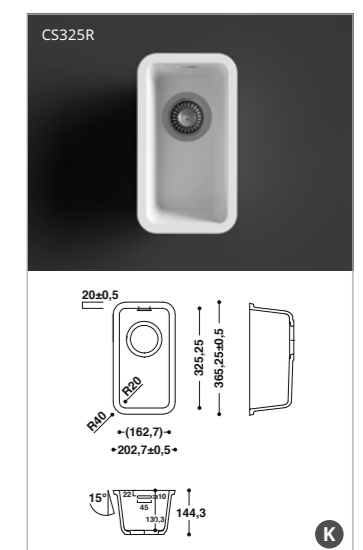
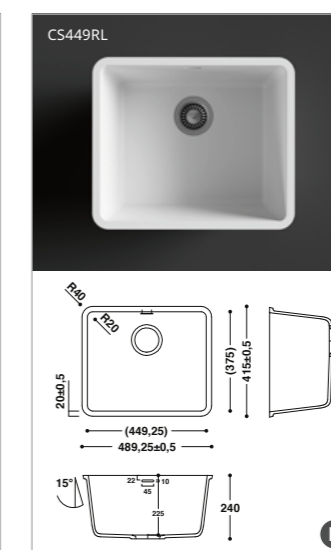
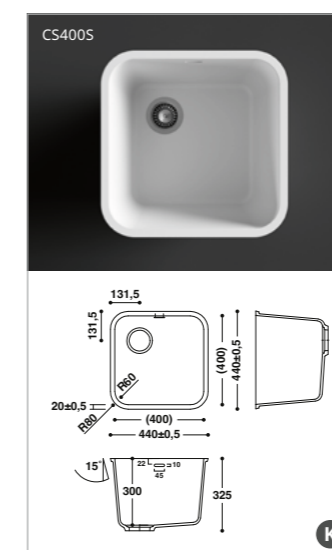
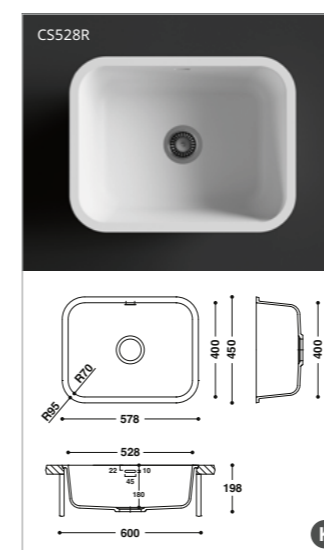
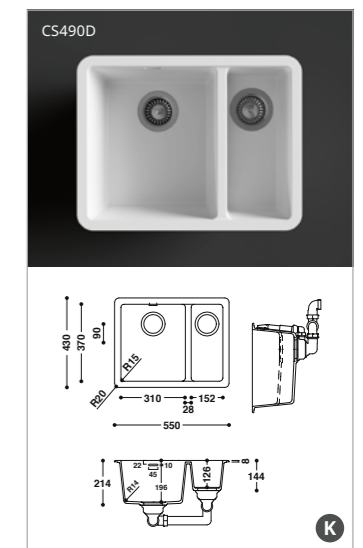
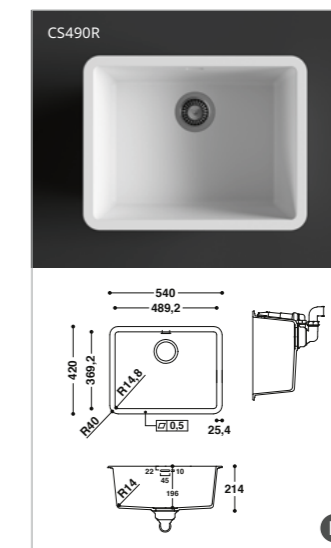

HIMACS Sinks for kitchen and healthcare applications

- The HIMACS sinks CS824D, CS490D are only available with overflow.
- All other HIMACS sinks are available with and without overflow.

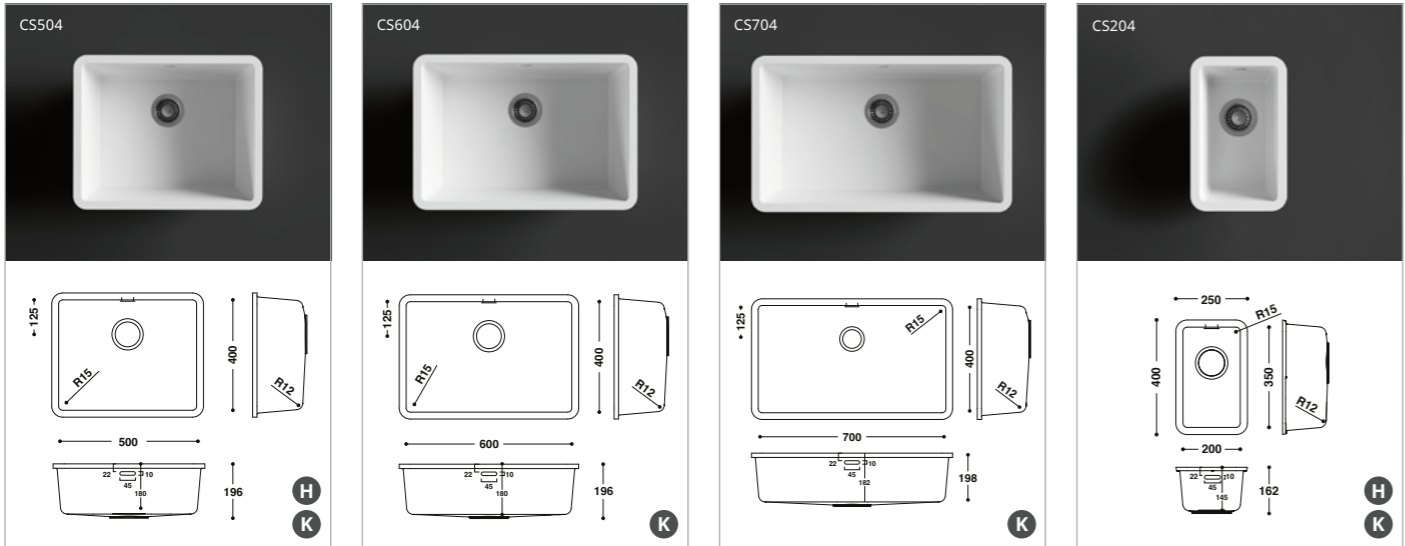
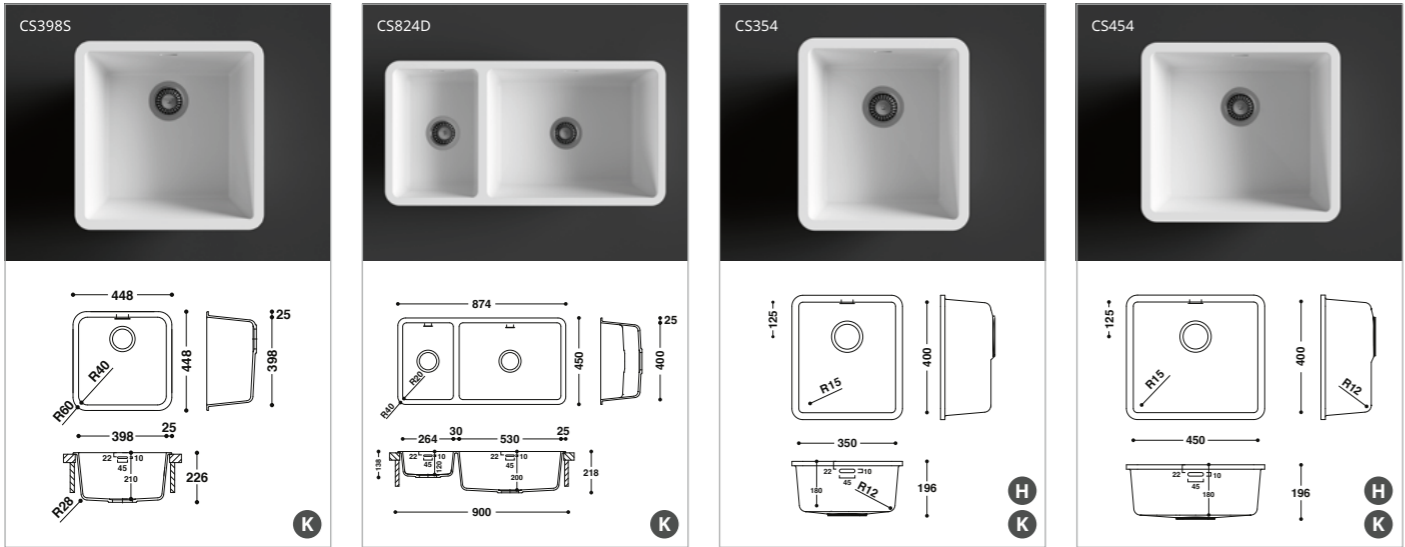
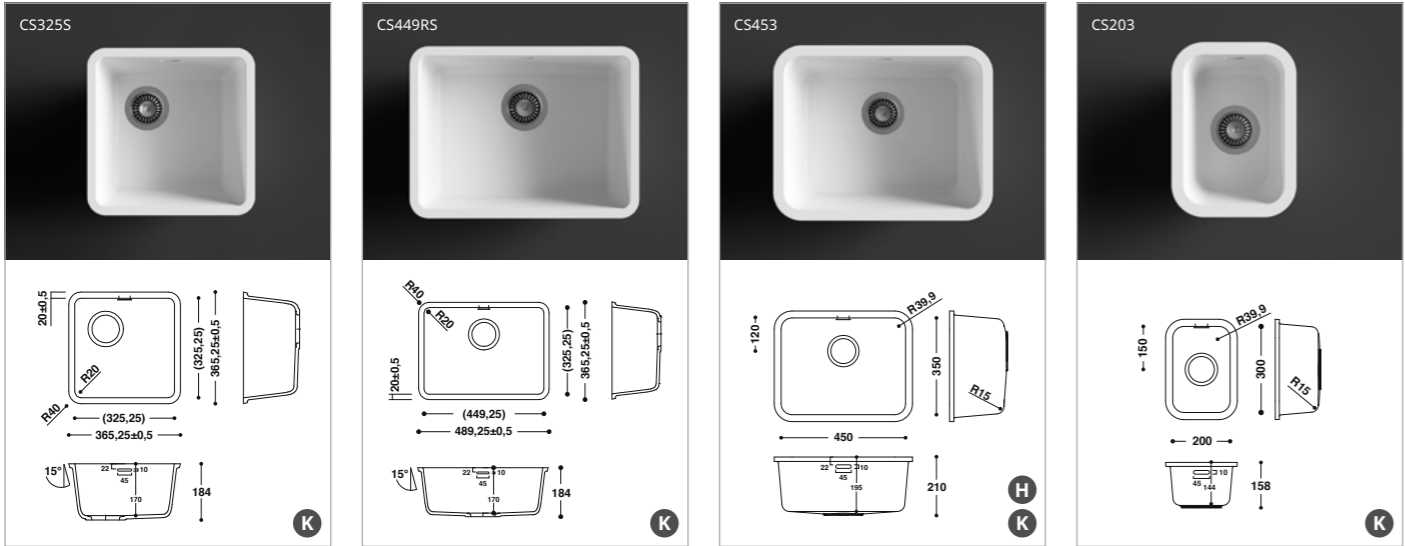

Basins.

Best design for the bathrooms.

Rectangular or oval, deep or shallow basins, small bathrooms or comprehensive solutions. The HIMACS range offers creative architects and bathroom planner's numerous options.

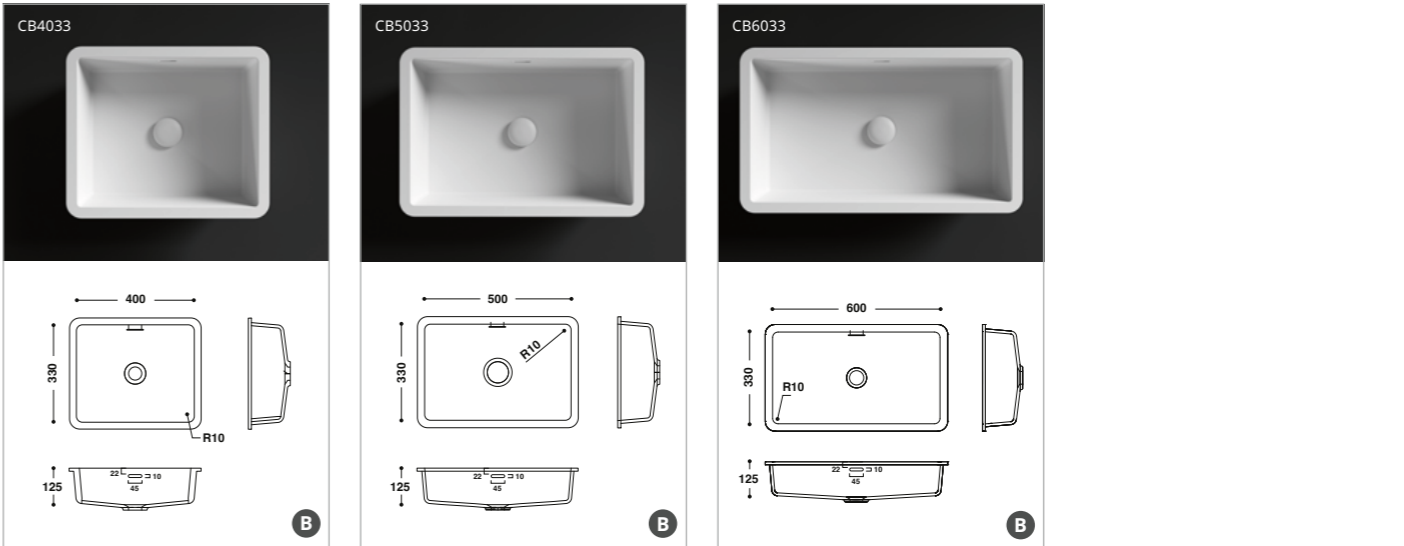
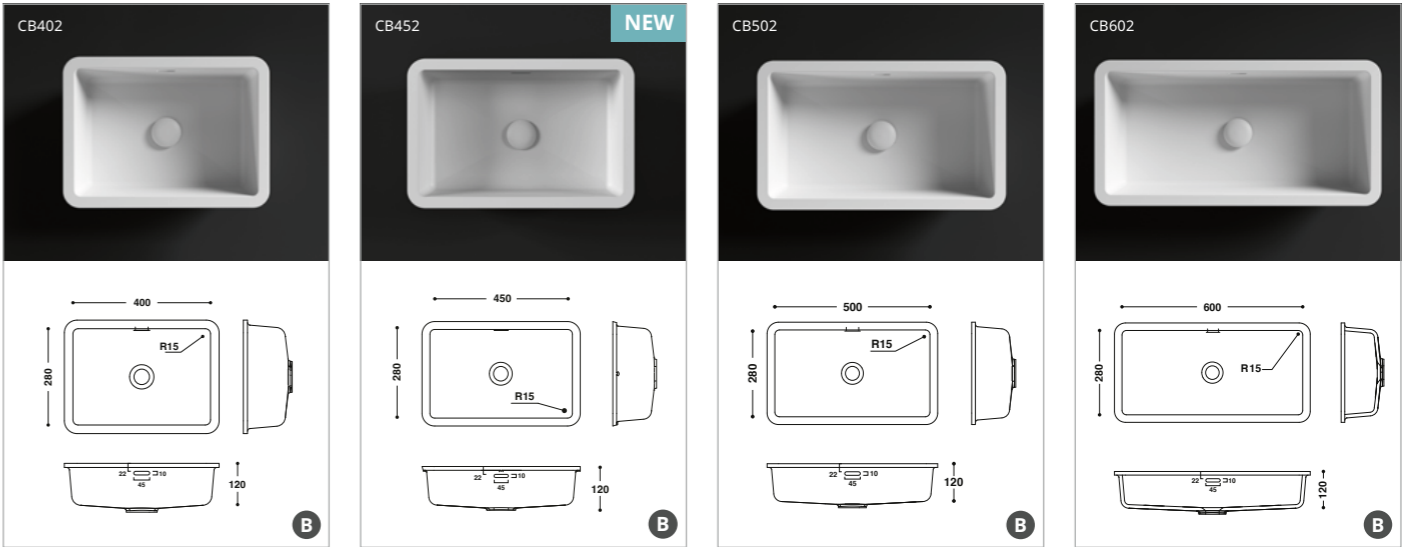

K suitable for kitchen

H suitable for healthcare

B suitable for bathrooms

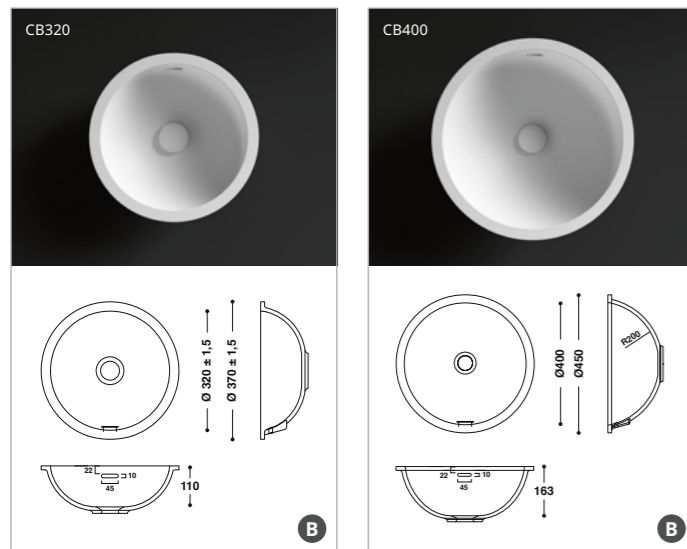
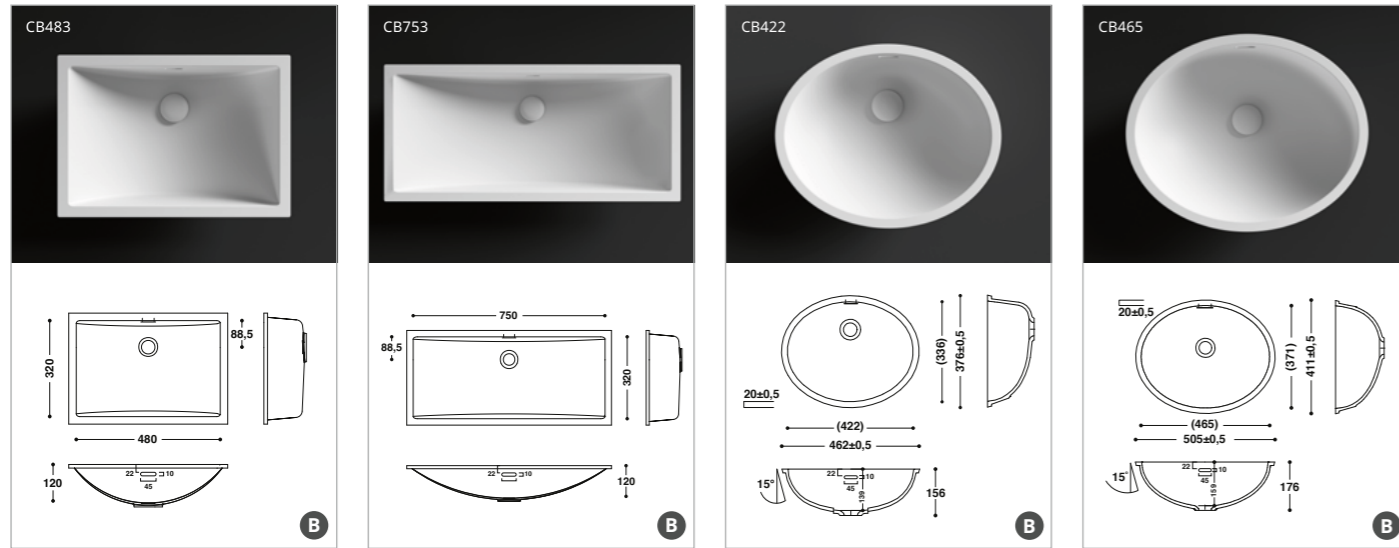

HIMACS Unique Models

- The HIMACS basins CB4430 comes with a solid surface valve included that is flush with the bottom of the basin



HIMACS Baby Bath

The neo-natal ward of a hospital is the one place where maximum hygiene, ergonomics and warmth are essential. The ergonomic shape of the bowl is specifically designed for babies.

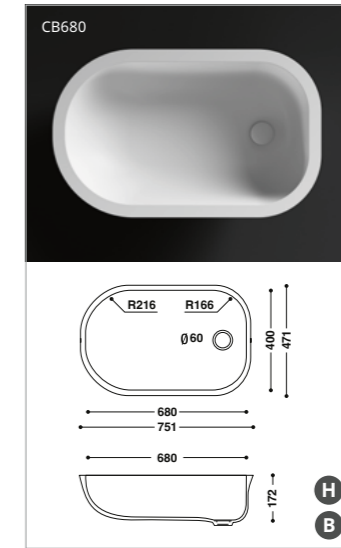

Top mount installation

These basins are HIMACS answer to the trend for linear designs. All three basins were exclusively designed as top-mounted bowls. The narrow radius of the two rectangular models creates exceptionally spacious basins.

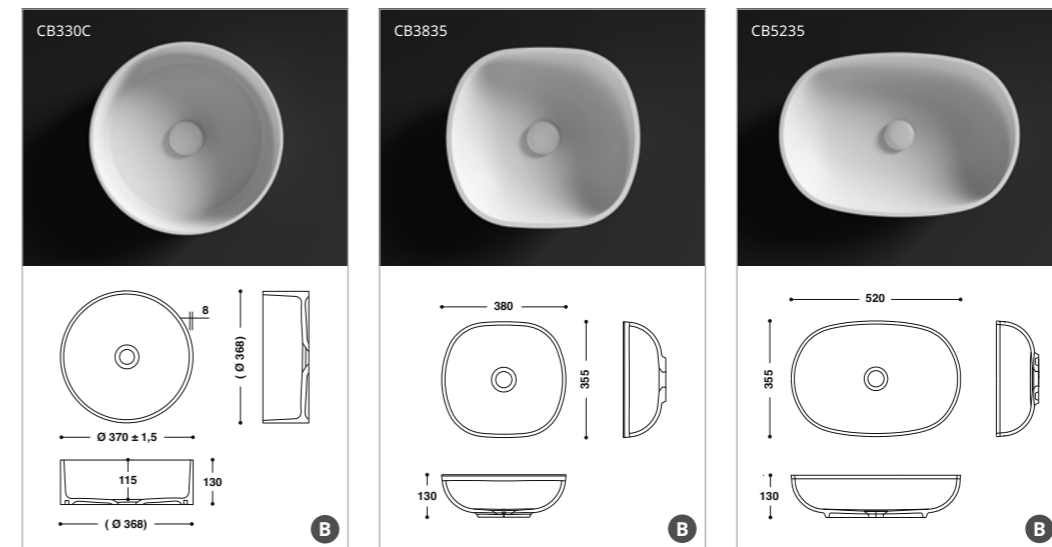
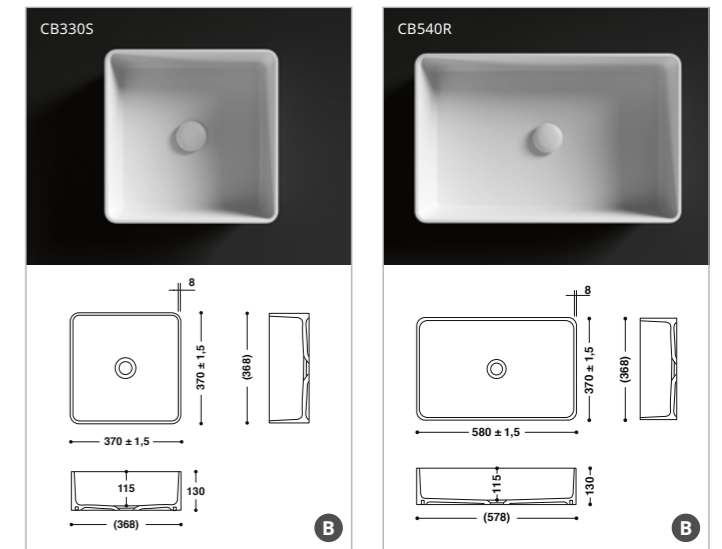

B suitable for bathrooms

H suitable for healthcare

NEW PRODUCT

CB4628

HIMACS PRM

for persons with reduced mobility

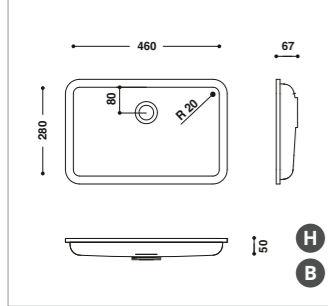

The models of the PRM series all have very shallow basins. The special design allows someone in a wheelchair to roll up to the sink and get close, for example.

- The HIMACS basins CB523, CB4232, CB6232, CB5530, CB4628, the HIMACS Top Mounted Basins Collection and the HIMACS Baby Bath are only available without overflow.
- All other HIMACS basins are available with and without overflow.

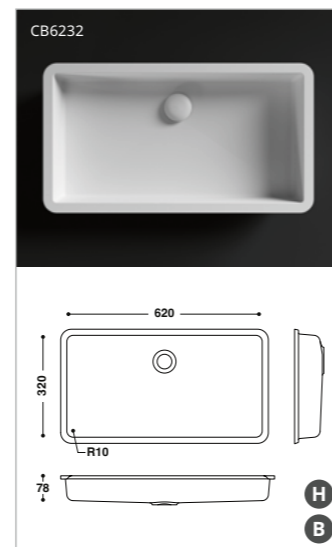
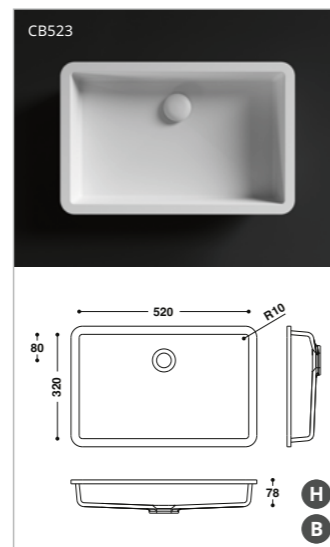
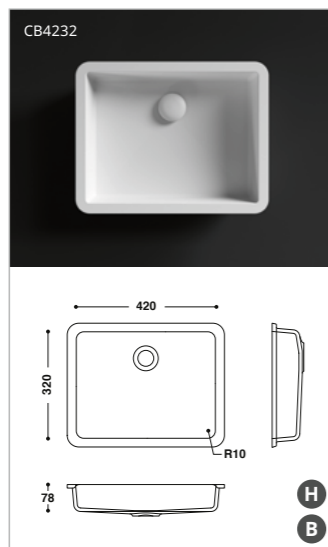

Shower Trays and Baths made of HIMACS

HIMACS Shower Trays

Three sleek, elegant models expand the possibilities for creative architects and designers to fit out the entire bathroom with HIMACS. The warm, soft-matt feel makes it very pleasant to touch HIMACS directly.

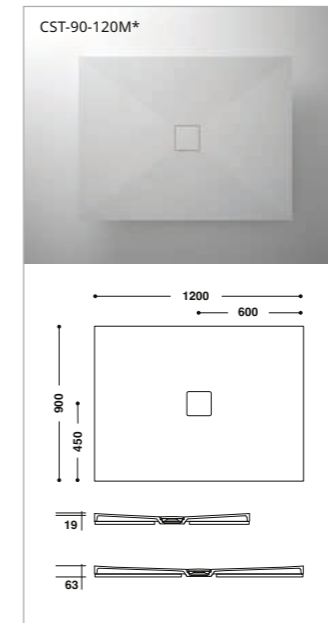

* Middle Drainhole

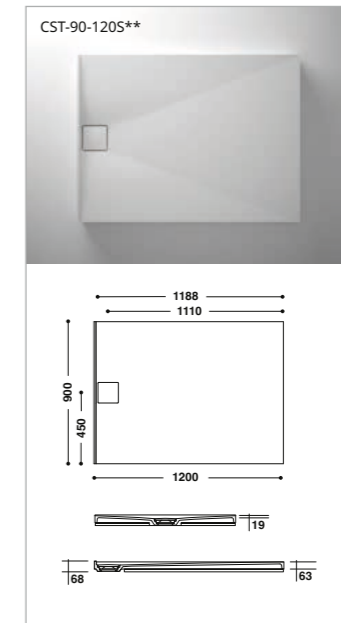

** Side Drainhole

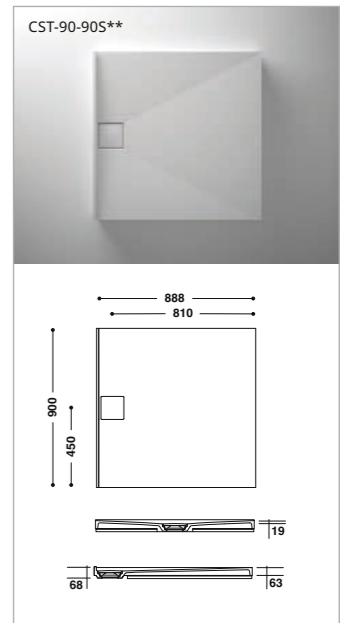

** Side Drainhole

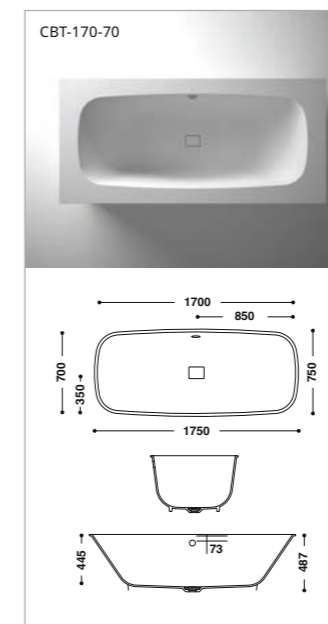
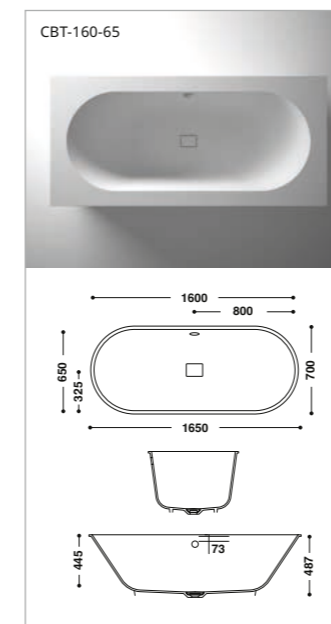

HIMACS Baths

In addition to sinks, the bath is the heart of any bathroom. And now both elements are available in the same material. All baths are designed for integrated installation. Functional benefits of seamless connection: the result is a continuous hygienic surface that is especially easy to maintain.

Please note:

1. The delivery includes either the bath or shower tray (as shown in the sketch)
2. The matching installation material consisting of height-adjustable feet, a soundinsulating mat and a wooden stabilisation board will be an additional option and can be ordered separately as an accessory.
3. Sheet material is also needed to create the installation seen in the photos.

B suitable for bathrooms

H suitable for healthcare

Looks like stone, gets fabricated like hardwood

Working with HIMACS is easy. Everything you need will already be in your workshop.



Quality is the result of many passionate experts

When you are 100% convinced of something, you have no doubt it's going to stand the test of time.



Well, we're those believers when it comes to HIMACS and its outstanding performance. That's why we offer our guarantee of 15 years, when it has been fabricated and installed by one of our Quality Club members.

Join the HIMACS Quality Club!
Certify your fabrication expertise by taking part in our Training Programme and become a HIMACS Quality Club Member.



As a woodworking expert, you only need to open your toolbox to find everything you need: you can saw, drill, and sand this material. And if you have a pre-heating oven or a heating press, you'll find it easy to heat the material for thermoforming too.

That's all there is to it: a carpentry workshop that specializes in timber materials, can be transformed in an instant into a company that also offers modern stone products.

Talking about the HIMACS Quality Club, where the members are our closest partners:

- Members receive a comprehensive training programme with the best trainers and the best working manual
- We cooperate closely on all material and work-related questions and guarantee comprehensive technical support
- We support our partners in sales, including forwarding specific project enquiries
- Support when pitching for projects

When the chemistry is right, it really works

We strongly believe in intensive research and development. Our LX Hausys engineers guarantee high-tech quality products.

An example? Our team invented the Thermalcure-technology to ensure superior performance to the standard in Solid Surface. You save precious time because it is easier to sand. And thanks to our innovative technology, HIMACS has excellent heat-resistance.

Don't worry, we're not done evolving just yet. Our teams continue to refresh and invent with more energy than before. That's a promise!

Chemical resistance

HIMACS is a fully homogenous material with no pores and is thus simple and easy to clean.

CLASS	STAINING AGENT	APPLICATION TIME	EVALUATION OF G002 CHANGES	EVALUATION OF S028 CHANGES
GROUP 1	Water	16h – 24h	5 to 4	5 to 4
	Toothpaste			
	Hand cream			
	Natural fruit and vegetable juice			
	Lemonade and fruit drinks			
	Meats and sausages			
	Animal and vegetable fats and oils			
	Yeast suspension in water			
	Salt (NaCl) solutions			
	Mustard			
	Lyes, soap solutions			
	Cleaning solution			
	Alcoholic beverages			
	Phenol and chloramine-T disinfectants			
Citric acid (10% solution)				
GROUP 2	Coffee (120 gr coffee per ltr. water)	16h	5	4 to 5
	Black tea (9gr tea per ltr. water)			
	Milk (all types)			
	Cola beverages			
	Wine vinegar			
	Alkaline-based cleaning agents (10% in water)			
	Hydrogen peroxide (3% solution)			
	Ammonia (10% solution of commercial concentrate)			
	Lipstick			
	Water colours			
	Laundry marking inks			
	Ball point inks			
GROUP 3	Sodium hydroxide (25% solution)	10min.	5 to 4	4 to 5
	Hydrogen peroxide (30% solution)			
	Acetone			
	Trichlorathane			
	Other organic solvents			
	Concentrated vinegar (30% acetic acid)			
	Bleaching agents and sanitary cleaners containing them			
	Hydrochloric acid based cleaning agents			
	Tincture of iodine			
	Boric acid			
	Lacquers and adhesives (except fast-curing materials)			
	Amidosulfonic acid descaling agents (≤10% solution)			
	Nail varnish			
	Nail varnish remover			
	Stain or paint remover based on organic solvents			
GROUP 4	Acetic acid (5% solution)	20min.	5	4

Tests carried out in accordance to EN ISO 19712 for Solid Surface material, please see table (left) for results.

Evaluation

RATING LEVEL	DESCRIPTION
Rating 5	No visible change
Rating 4	Slight change in gloss and/or colour, only visible at certain viewing angles
Rating 3	Moderate change in gloss and/or colour
Rating 2	Marked change in gloss and/or colour
Rating 1	Surface distortion and/or blistering

a = Acids and alkalis, in concentrations stronger than those shown in group 3, which can be contained in commercial cleaning agents, can cause surface damage or marking, even with very short contact times. Any spillage of such materials should be washed off immediately.

Technical data sheet

HIMACS is extremely resistant to dirt and wear and tear, so that you can enjoy many years' peace of mind with the outstanding quality of your new product.

SPECIFICATION	UNIT	RESULT SOLIDS	RESULT GRANITE	TEST METHODS
Flexural-E-modulus	MPa	8900	7730	DIN EN ISO 178
Flexural strength	MPa	70.1	64.3	ASTM D638
Breaking elongation	%	1	1.1	DIN EN ISO 178
Tensile strength	MPa	69.5	56.3	DIN EN ISO 527
Density	g/cm ³ kg/m ³	1.75 1750	1.65 1650	ISO 1183 ISO 1183
Ball indentation hardness	N/mm ²	257	239	DIN EN ISO 2039-1
Mohs hardness		2 to 3	2 to 3	EN 101
Pencil hardness		>9H	>9H	ISO 15184
Water absorption Weight Strength/thickness		<0,1% <0,1%	<0,1% <0,1%	DIN EN 438 Part 12
Impact resistance Impactor Drop ball test (fall height)	N mm	≥25 ≥1500	≥25 ≥1500	E DIN EN 438, 02/02 Part 2/20 E DIN EN 438, 02/02 Part 2/21
Slip resistance		>0,32 – 0,9		GMG100 (replaces R9)
Slip resistance		angle of acceptance of more than 10° to 19° = R10		DIN 51130
Climate change resistance	°C	≥0,05	≥0,05	AMK
Dry heat (pan base)	°C	≥100 (7C)		DIN 68 861, Part 7, 04-'85
Damp heat (pan base)	°C	≥100 (7C)		DIN 68 861, Part 8, 04-'85
Temperature change resistance	°C	no change		UNI 9429
Resistance to cigarette burns		6C	6B	DIN 68 861, Part 6, 11-'82
Scratch resistance		4D	4B	DIN 68 861, Part 4, 11-'81
Electrostatics Conductivity	1 x 10 ¹² Ω	insulating non-conductive		DIN IEC 1340-4-1, 04-'92 EN 61340-5-1
Thermal conductivity	W/mK	0.636	0.55	DIN EN 12664
Thermal resistance	m ² K/W	0.038	0.045	DIN EN 12664
Thermal Expansion Coefficient For Standard HIMACS Products	mm/mK m/m°C	0.045 45 x 10 ⁻⁶	0.055	DIN EN 14581
Water vapor transmission properties – diffusion resistance factor	μ	18607	16150	DIN EN ISO 12572
Dimensional change by change in relative humidity Length Thickness Mass	% % %	-0.03 0.06 0.05	-0.02 0.03 0.05	DIN EN 318, edit. 5, 1998
Resistance to boiling water Increase in weight Increase in thickness	% %	<0,1 <0,1	>0,1 <0,1	E DIN EN 438, 02/02 Part 2/12
Light fastness (Xenon)	scale 0 – 10	better than 6	better than 6	DIN 53 387, 04-'89
Food tolerance		suitable for all colours		LMBG § 31
Hygiene		suitable	suitable	LGA Hygiene Certificate

HIMACS Fire Classification

MATERIAL CATEGORY	MATERIAL THICKNESS	PRODUCT TESTED	TEST METHOD	RESULT
HIMACS Standard range	12 mm	HIMACS colour range*, M551, G554, Q001, Z005.	DIN 4102	B1
		S028	DIN 4102	B1
		S028	DIN 5510	passed (S4 / SR2 / ST2 and FED30 < 1)
		S028, T017, VW01, W001	NF P92-501	M1
		HIMACS colour range*	EN 13501-1	B – s1 – d0
		S028E	EN 13501-1	B – s1 – d0
HIMACS Special Formulations	12 mm	S028	EN 13501-1	B – s1 – d0
		S728 CE MED	DIN 4102	B1
		S728 CE MED	EN 13501-1 / SBI	B – s1 – d0
		S728 CE MED	EN 45545	passed R1/HZ3
		IMO S728 CE MED + IMO colour range in Solids *	Module B & Module D	IMO certified
		S928 Ultra-Thermoforming	DIN 4102	B1
HIMACS Exteria®	12 mm	S928 Ultra-Thermoforming	EN 13501-1	B – s1 – d0
		S922U Intense Ultra	DIN 4102	B1
		S728 HIMACS-FR	DIBT	ETA
		S728 HIMACS-FR, S828 HIMACS-UV+	NF P92-501	M1

* For details of HIMACS colour range please contact your sales representative or refer to our reports: 2019-2213, 167467, 347196, MED233220CS, 210646-K1.

Wherever you are, we have a great partner waiting to meet you.

Contact us to find a network of exclusive distributors serving more than 5,000 fabricators across Europe and our numerous Quality Club Training Centres.

We can also offer you the security of our global LX Hausys After-sales Service with our experienced HIMACS experts all around the world.

Sounds good? All contact details of our network can be found at lxhausys.com/eu



Please feel free to contact us for further information.

HIMACS. The shape of your ideas.

European Headquarters:
LX Hausys Europe GmbH
Lyoner Str. 15
60528 Frankfurt am Main
Germany
himacseu@lxhausys.com



lxhausys.com/eu

To find the contact for your region, please visit our website.

HIMACS and HIMACS Exteria® are registered trademarks of LX Hausys Europe GmbH. All other trademarks and product names are trademarks or registered trademarks of their respective rights owners. The information contained in this brochure is intended to be for information only and can be amended at any time without prior notification. ©2024. LX Hausys Europe GmbH. All rights reserved.

